



Report No.:

Test Time: 04/09/2018 10:08

## Luminaire Property

Luminaire Manufacturer: Lighting Line  
 Luminaire Description: LLP-SL06-05 + LLD-05-FK  
 Lamp Description: Strip 14,4W/m 60led/m Number of Lamps: 1  
 Lumens per Lamp: 1579 lm Voltage: 24.0 V  
 Current: 0.599 A Power: 14.38 W  
 Power Factor: 1.000

## Photometric Results

CIE Class: Direct	Total Rated Lamp Lumens: 1579.0 lm
Measurement Flux: 1352.4 lm	Efficiency: 85.65%
Downward Ratio: 85.31%	Upward Ratio: 0.34%
Field Angle(C0/C180,C90/C270,C45/C225,C135/315): 154.3, 118.8, 126.6, 126.7	
Beam Angle(C0/C180,C90/C270,C45/C225,C135/315): 113.0, 97.8, 112.7, 112.7	
Luminaire Efficacy Rating (LER): 94.10	Central Intensity: 536.35 cd
Max. Intensity: 536.98 cd	Pos of Max. Intensity: H200 V1
S/MH(C0/C180): 1.28	S/MH(C90/C270): 1.33

Picture Of Luminaire

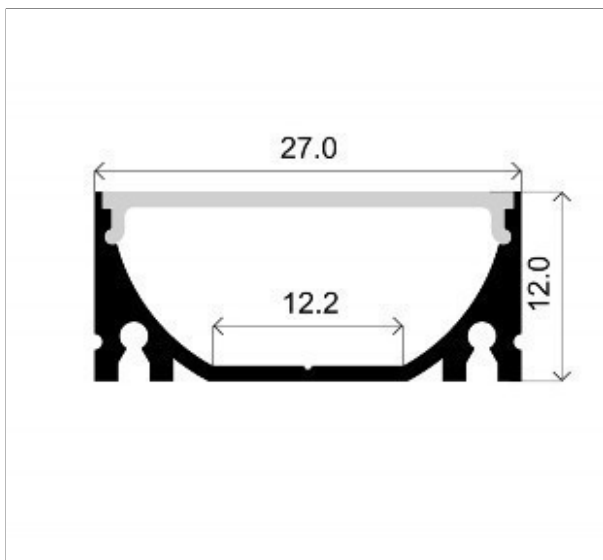

Luminous Intensity Distribution Curve

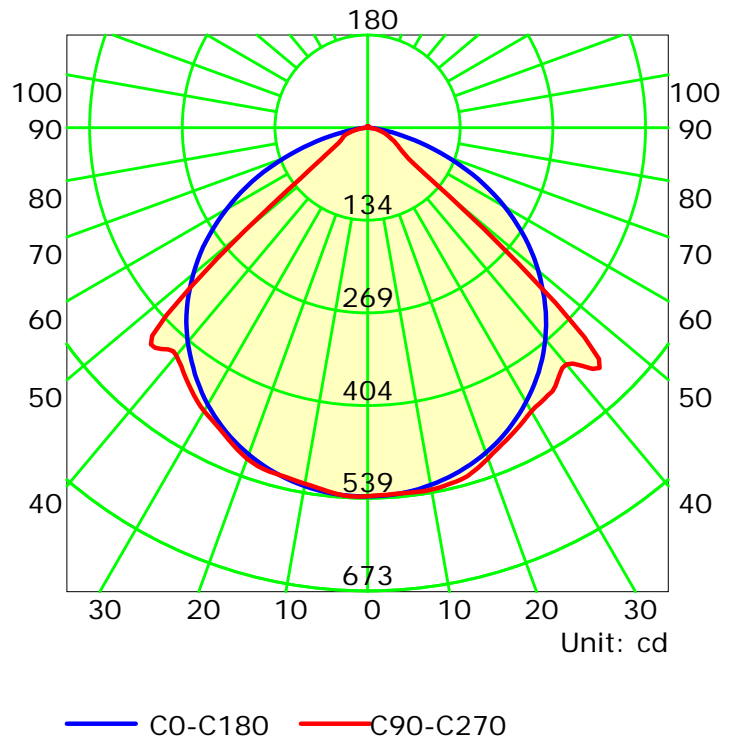

C Plane (°):0.0-360.0: 10.0  
 Test Lab:  
 Test Type: TYPE C  
 Temperature:  
 Operator:

Gamma Plane (°):0.0-180.0:1.0  
 Test Device: GPM-2000  
 Distance: 7.970 m  
 Humidity:  
 Inspector:



## Luminous Intensity Distribution Curve

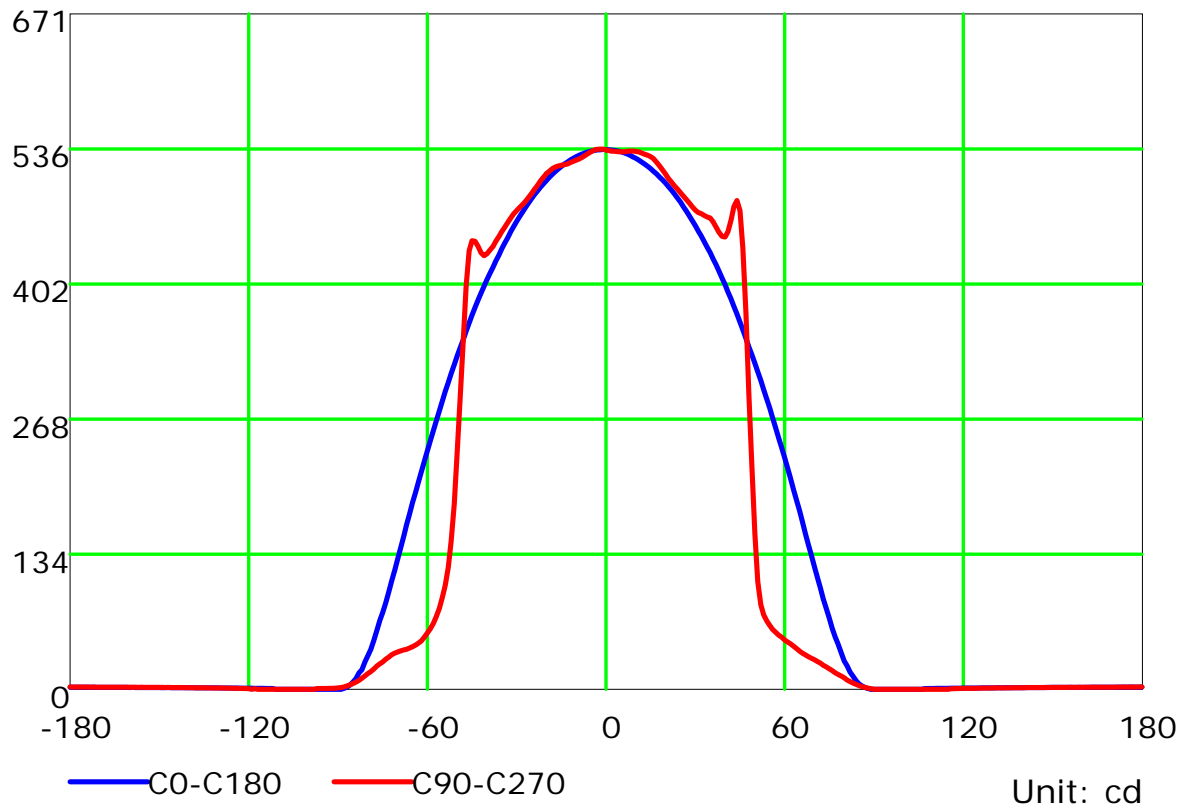
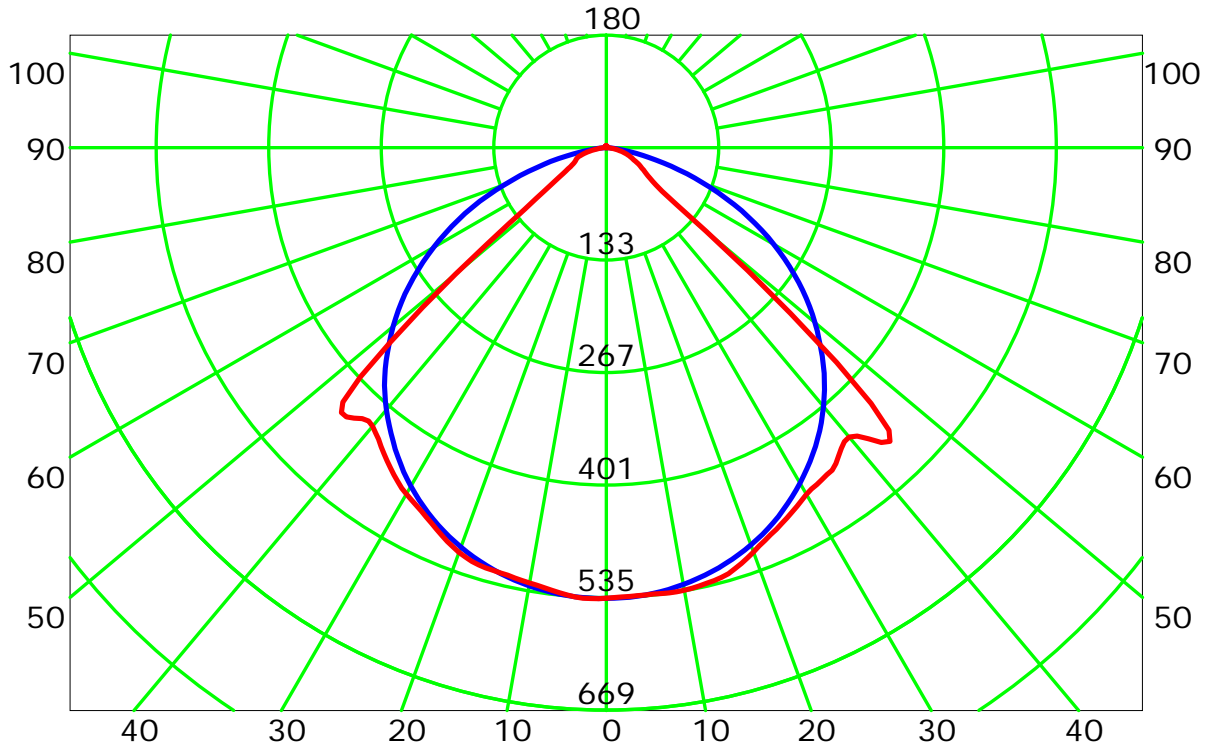

C Plane (°):0.0-360.0: 10.0  
 Test Lab:  
 Test Type: TYPE C  
 Temperature:  
 Operator:

Gamma Plane (°):0.0-180.0:1.0  
 Test Device: GPM-2000  
 Distance: 7.970 m  
 Humidity:  
 Inspector:



## Luminous Intensity Distribution Curve(cd/klm)

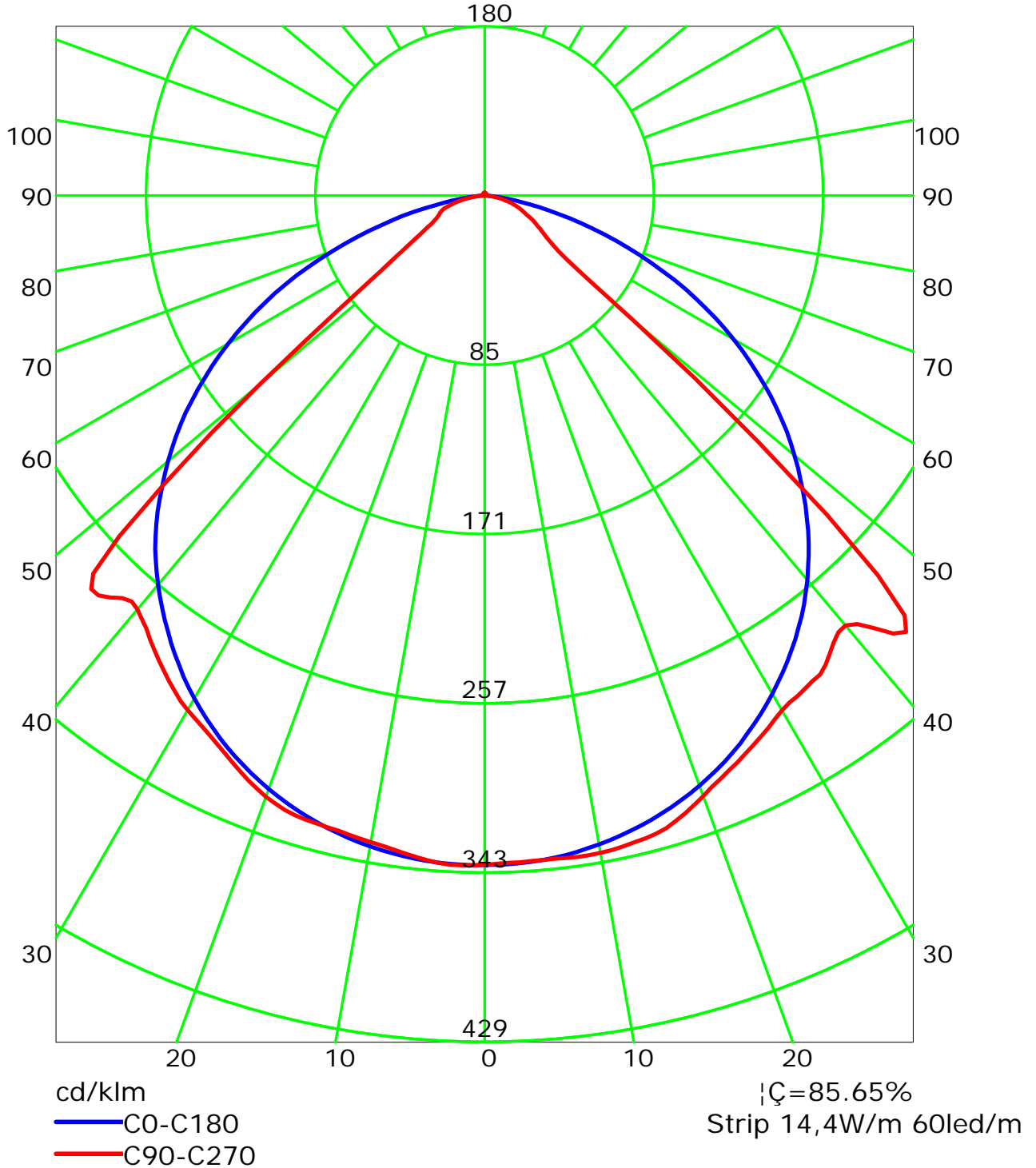

C Plane (°):0.0-360.0: 10.0  
Test Lab:  
Test Type: TYPE C  
Temperature:  
Operator:

Gamma Plane (°):0.0-180.0:1.0  
Test Device: GPM-2000  
Distance: 7.970 m  
Humidity:  
Inspector:



## Isocandela (rectangle)

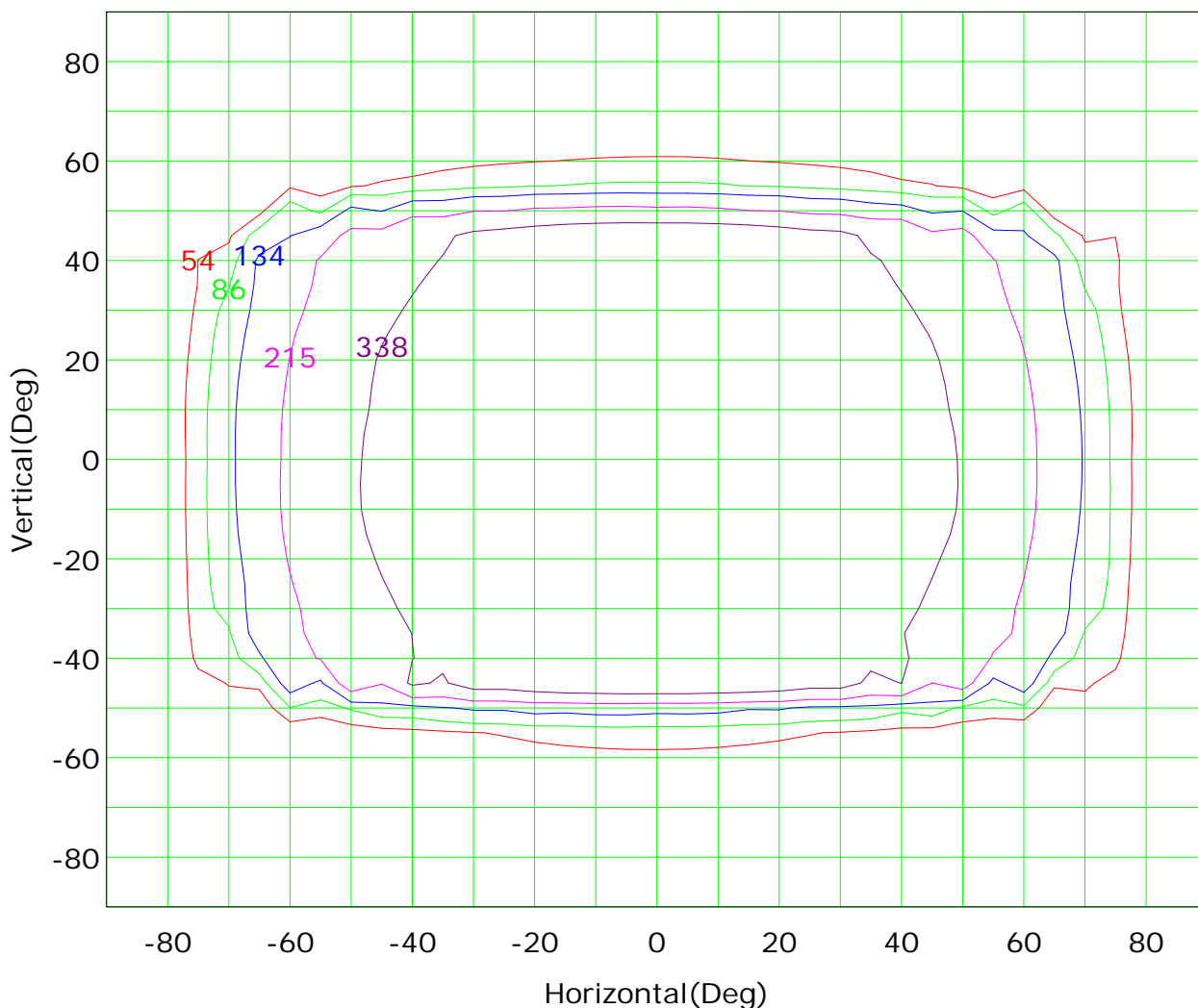

Imax (100%): 537 cd

— ( 10%):	54 cd	— ( 16%):	86 cd
— ( 25%):	134 cd	— ( 40%):	215 cd
— ( 63%):	338 cd	— (100%):	537 cd

C Plane (°):0.0-360.0: 10.0

Test Lab:

Test Type: TYPE C

Temperature:

Operator:

Gamma Plane (°):0.0-180.0:1.0

Test Device: GPM-2000

Distance: 7.970 m

Humidity:

Inspector:



## Isocandela (sphere)

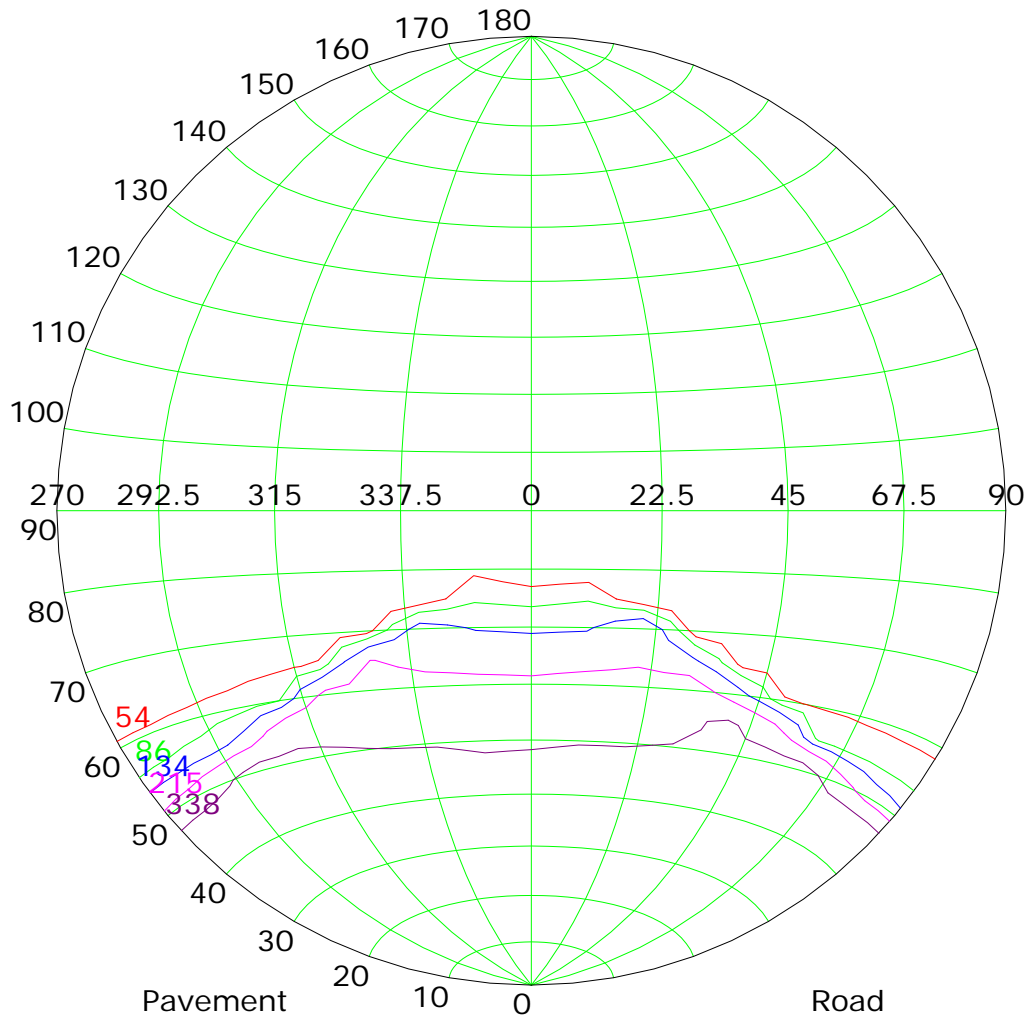

Imax (100%): 537 cd

— ( 10%):	54 cd	— ( 16%):	86 cd
— ( 25%):	134 cd	— ( 40%):	215 cd
— ( 63%):	338 cd	— (100%):	537 cd

C Plane (°):0.0-360.0: 10.0

Test Lab:

Test Type: TYPE C

Temperature:

Operator:

Gamma Plane (°):0.0-180.0:1.0

Test Device: GPM-2000

Distance: 7.970 m

Humidity:

Inspector:



## IsoLux Plot

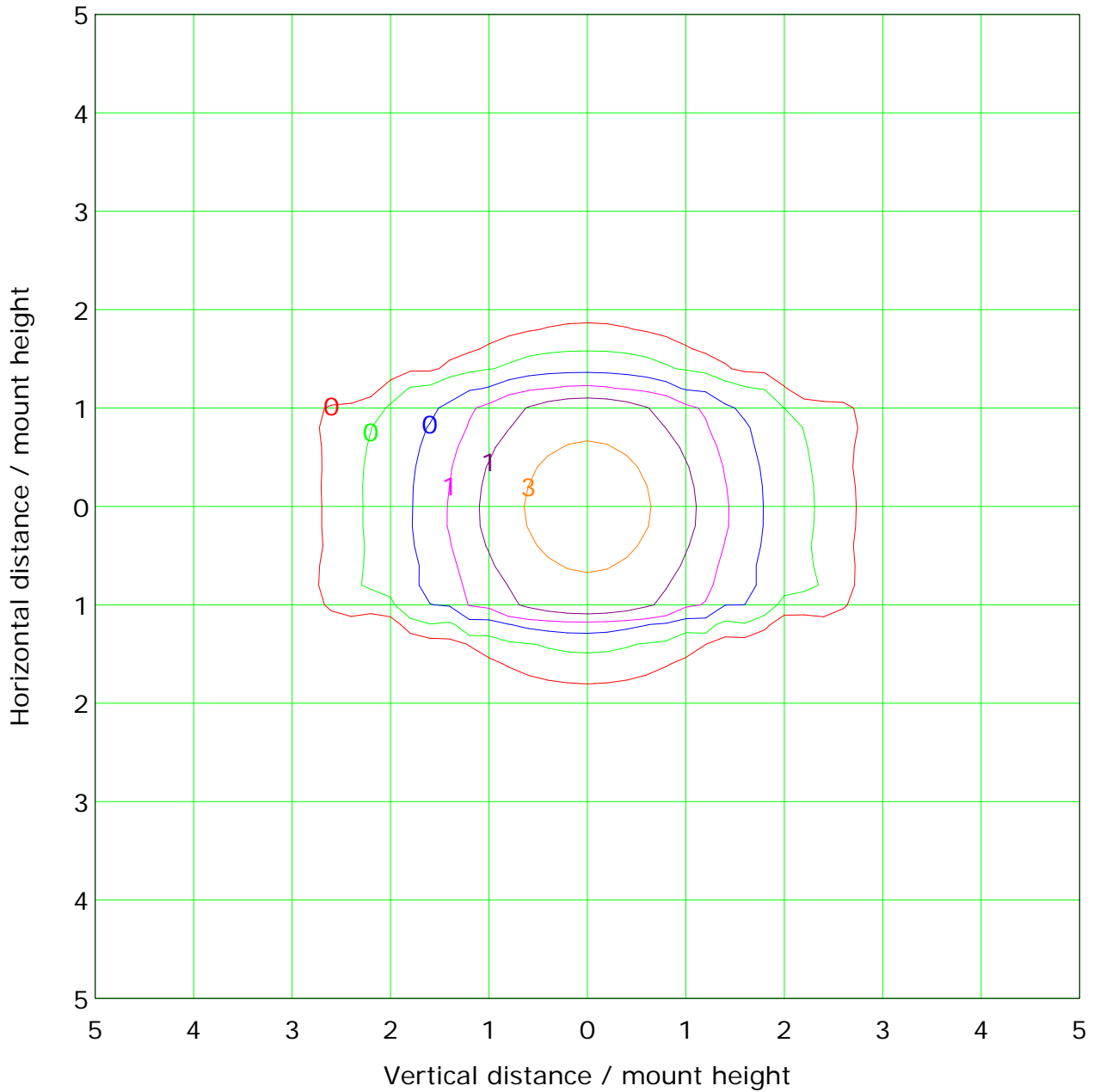

Mounting Height: 10.0m		Max Lux(100%): 5.4 lx	
— ( 1%):	0.1 lx	— ( 2%):	0.1 lx
— ( 5%):	0.3 lx	— (10%):	0.5 lx
— (20%):	1.1 lx	— (50%):	2.7 lx
— (100%):	5.4 lx		

C Plane (°):0.0-360.0: 10.0  
 Test Lab:  
 Test Type: TYPE C  
 Temperature:  
 Operator:

Gamma Plane (°):0.0-180.0:1.0  
 Test Device: GPM-2000  
 Distance: 7.970 m  
 Humidity:  
 Inspector:



## Lum Limit Curve

Dazzle	Quality	Illuminance (lx)							
		a	b	c	d	e	f	g	h
1.15	A	2000	1000	500	<=300				
1.50	B		2000	1000	500	<=300			
1.85	C			2000	1000	500	<=300		
2.20	D				2000	1000	500	<=300	
2.55	E					2000	1000	500	<=300



L(cd/sq.m)	G45	G50	G55	G60	G65	G70	G75	G80	G85
C0	365	324	280	230	178	122	71	28	5
C90	476	155	63	49	38	29	20	12	4
C180	372	331	286	237	186	129	76	33	7
C270	446	235	91	56	42	37	27	16	6

C Plane (°):0.0-360.0: 10.0  
 Test Lab:  
 Test Type: TYPE C  
 Temperature:  
 Operator:

Gamma Plane (°):0.0-180.0:1.0  
 Test Device: GPM-2000  
 Distance: 7.970 m  
 Humidity:  
 Inspector:



## Illuminance at a Distance

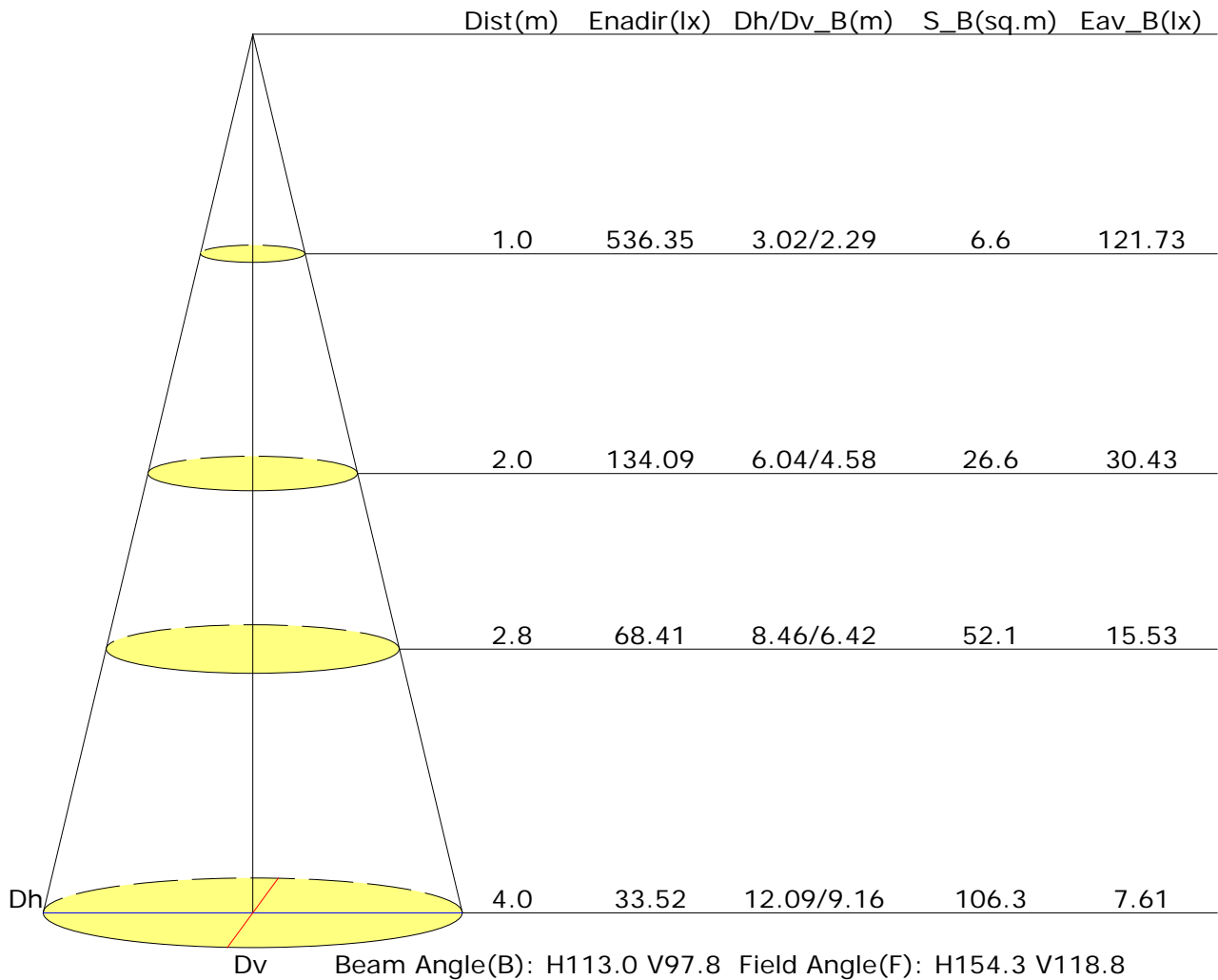





## Vertical IsoLux Plot

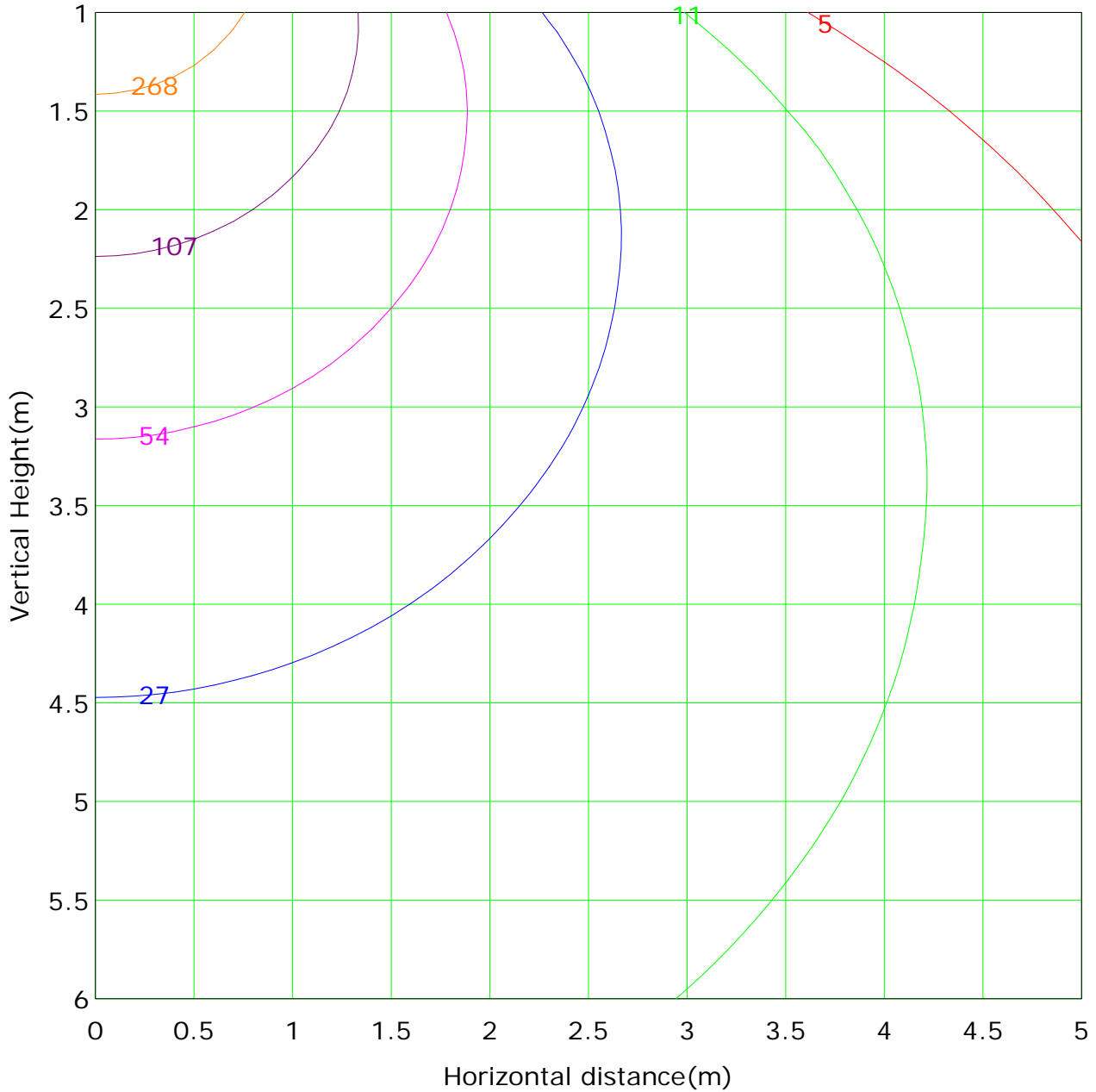

Lowest(m): 1.0m	Highest(m): 6.0m	Max Lux: 536.3 lx
( 1%): 5.4 lx	( 2%): 10.7 lx	
( 5%): 26.8 lx	( 10%): 53.6 lx	
( 20%): 107.3 lx	( 50%): 268.2 lx	
(100%): 536.3 lx		

C Plane (°):0.0-360.0: 10.0  
 Test Lab:  
 Test Type: TYPE C  
 Temperature:  
 Operator:

Gamma Plane (°):0.0-180.0:1.0  
 Test Device: GPM-2000  
 Distance: 7.970 m  
 Humidity:  
 Inspector:



Report No.:

Test Time: 04/09/2018 11:07

## Luminaire Property

Luminaire Manufacturer: Lighting Line

Luminaire Description: LLP-SL06-05 + LLD-05-FM

Lamp Description: Strip 14,4W/m 60led/m Lumens per Lamp: 1579 lm

Voltage: 24.0 V Current: 0.595 A

Power: 14.26 W Power Factor: 1.000

## Photometric Results

CIE Class: Direct

Measurement Flux: 1073.8 lm

Downward Ratio: 100%

Field Angle(C0/C180,C90/C270,C45/C225,C135/315): 159.4, 159.5, 159.6, 159.6

Beam Angle(C0/C180,C90/C270,C45/C225,C135/315): 110.4, 109.5, 110.1, 110.1

Luminaire Efficacy Rating (LER): 75.35

Max. Intensity: 387.77 cd

S/MH(C0/C180): 1.24

Total Rated Lamp Lumens: 1073.8 lm

Efficiency: 100%

Upward Ratio: 0%

Central Intensity: 387.76 cd

Pos of Max. Intensity: H0 V0

S/MH(C90/C270): 1.23

Picture Of Luminaire

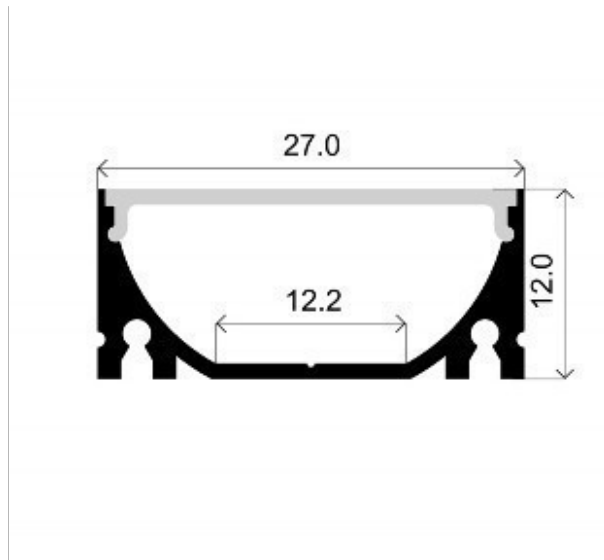

Luminous Intensity Distribution Curve

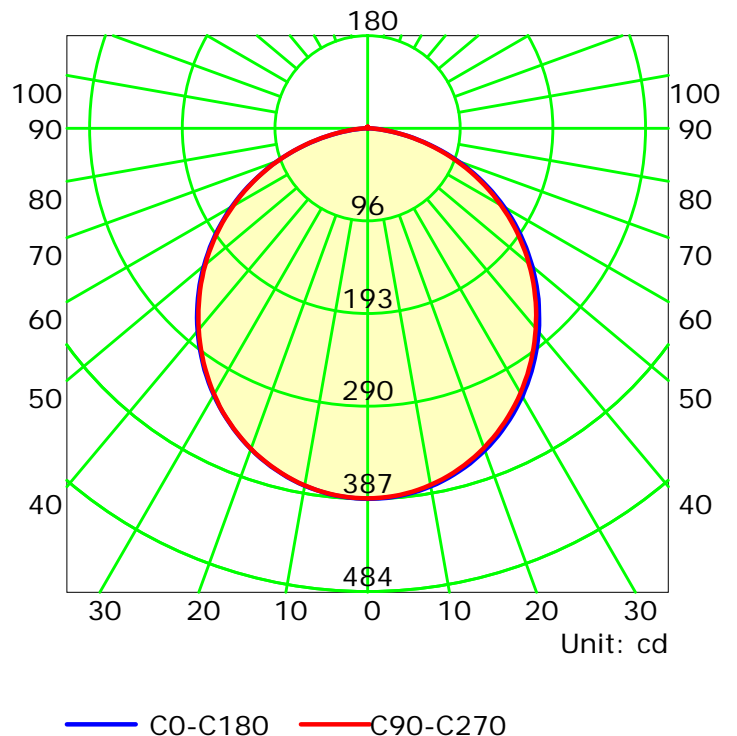

C Plane (°):0.0-360.0: 10.0

Test Lab:

Test Type: TYPE C

Temperature:

Operator:

Gamma Plane (°):0.0-180.0:1.0

Test Device: GPM-2000

Distance: 7.970 m

Humidity:

Inspector:



## Luminous Intensity Distribution Curve

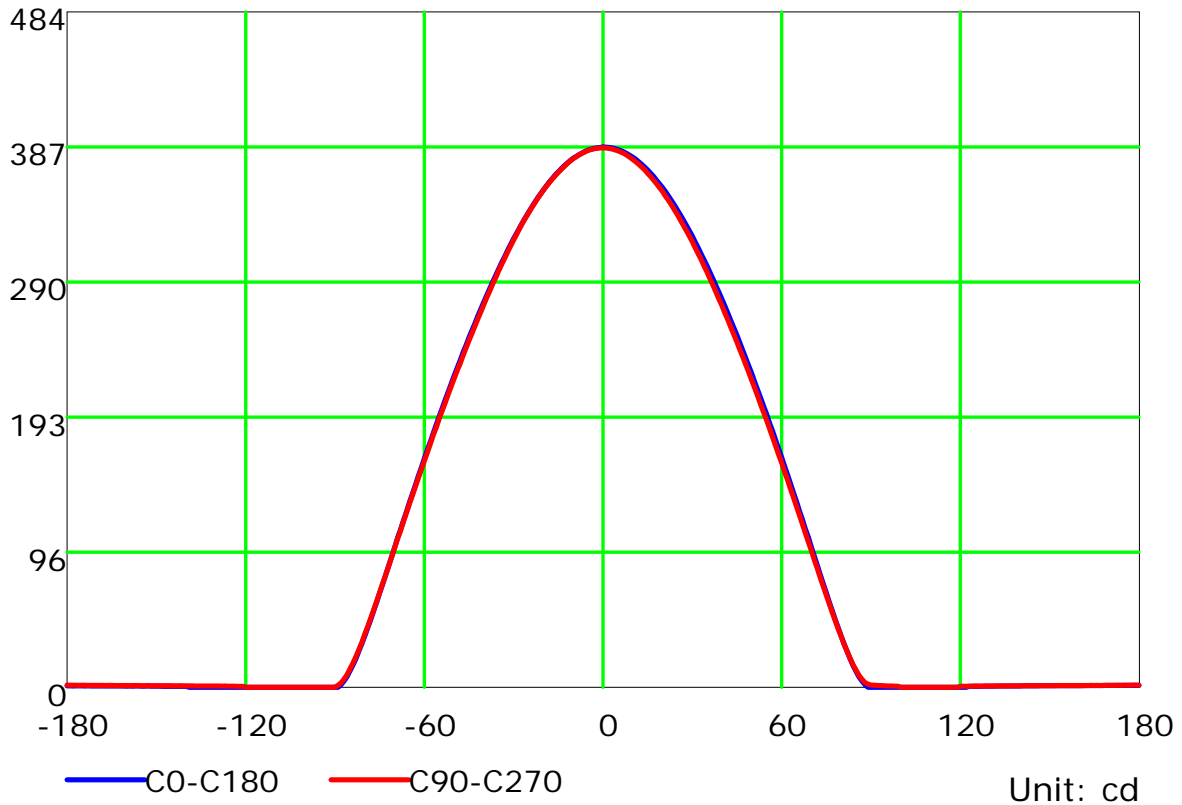
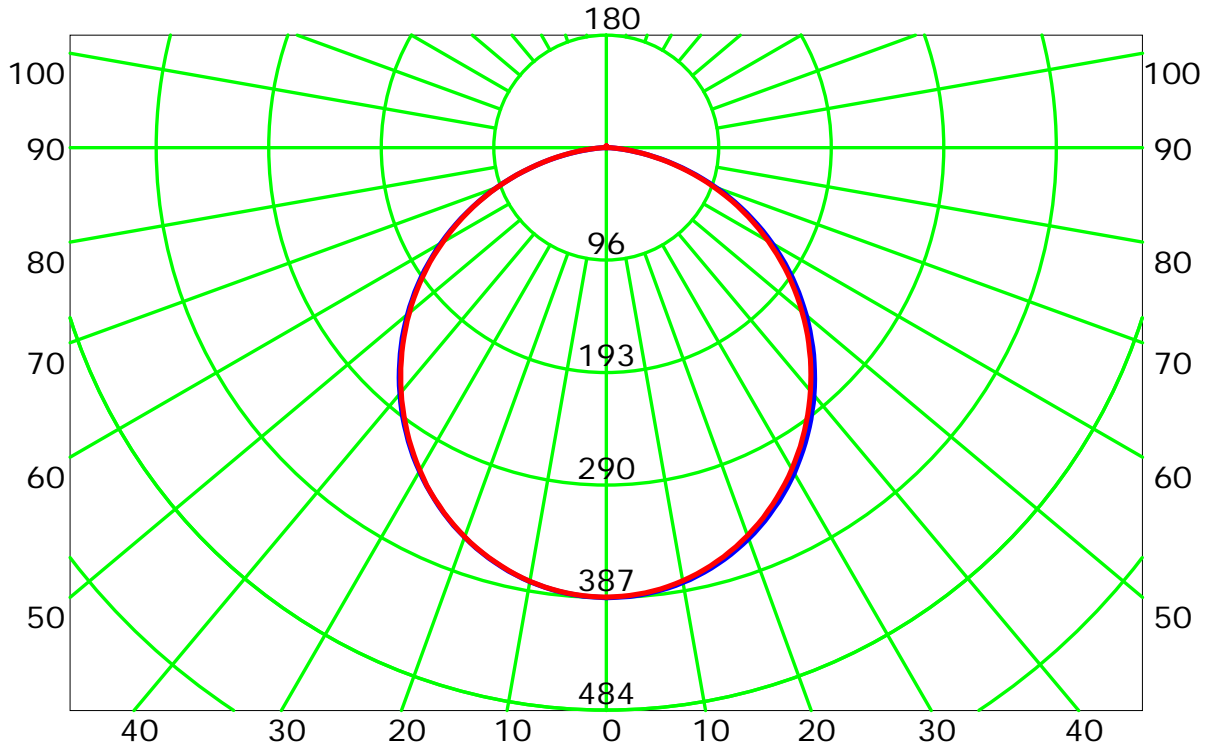

C Plane (°):0.0-360.0: 10.0  
 Test Lab:  
 Test Type: TYPE C  
 Temperature:  
 Operator:

Gamma Plane (°):0.0-180.0:1.0  
 Test Device: GPM-2000  
 Distance: 7.970 m  
 Humidity:  
 Inspector:



## Luminous Intensity Distribution Curve(cd/klm)

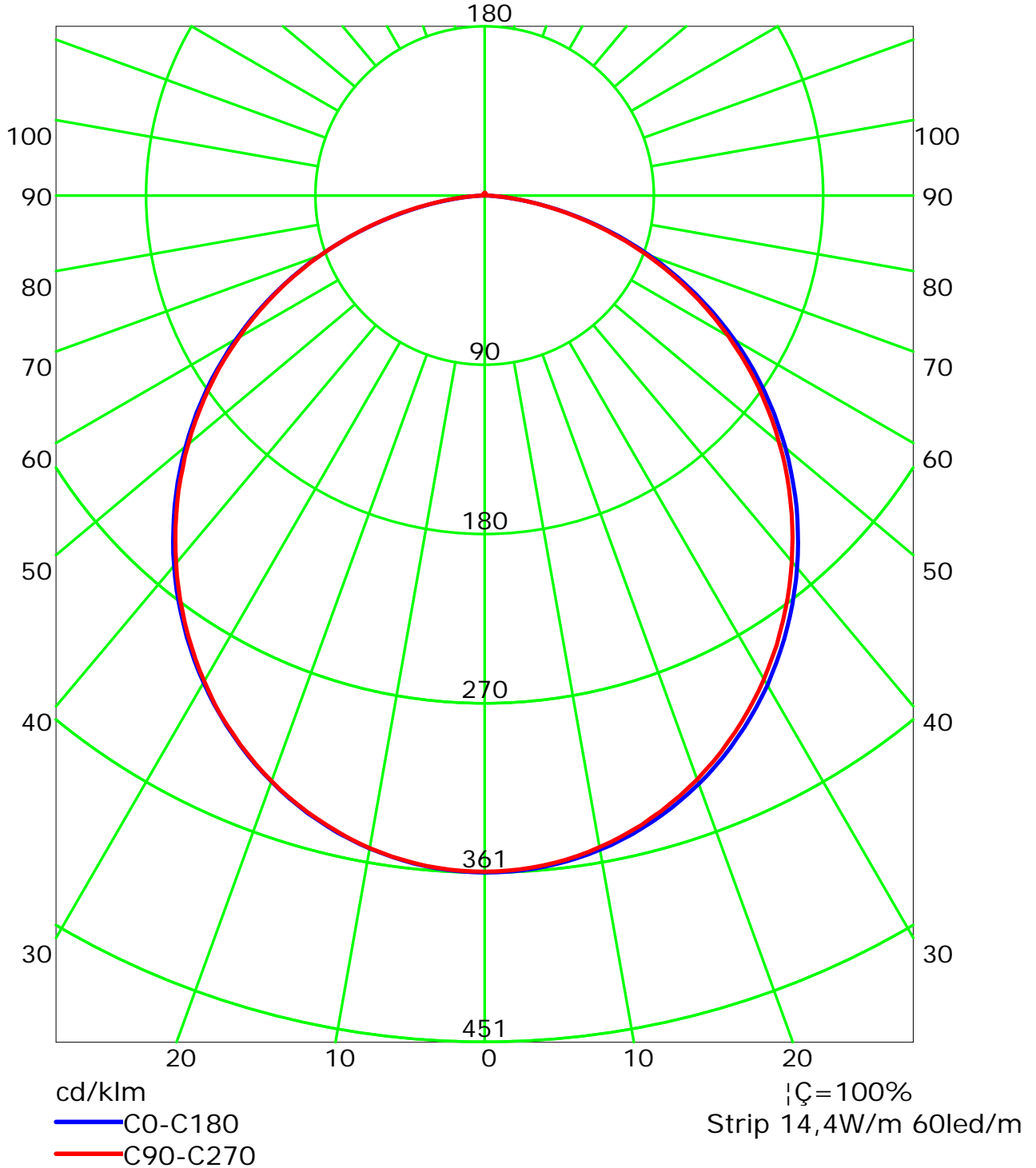

C Plane (°):0.0-360.0: 10.0  
 Test Lab:  
 Test Type: TYPE C  
 Temperature:  
 Operator:

Gamma Plane (°):0.0-180.0:1.0  
 Test Device: GPM-2000  
 Distance: 7.970 m  
 Humidity:  
 Inspector:



## Isocandela (rectangle)

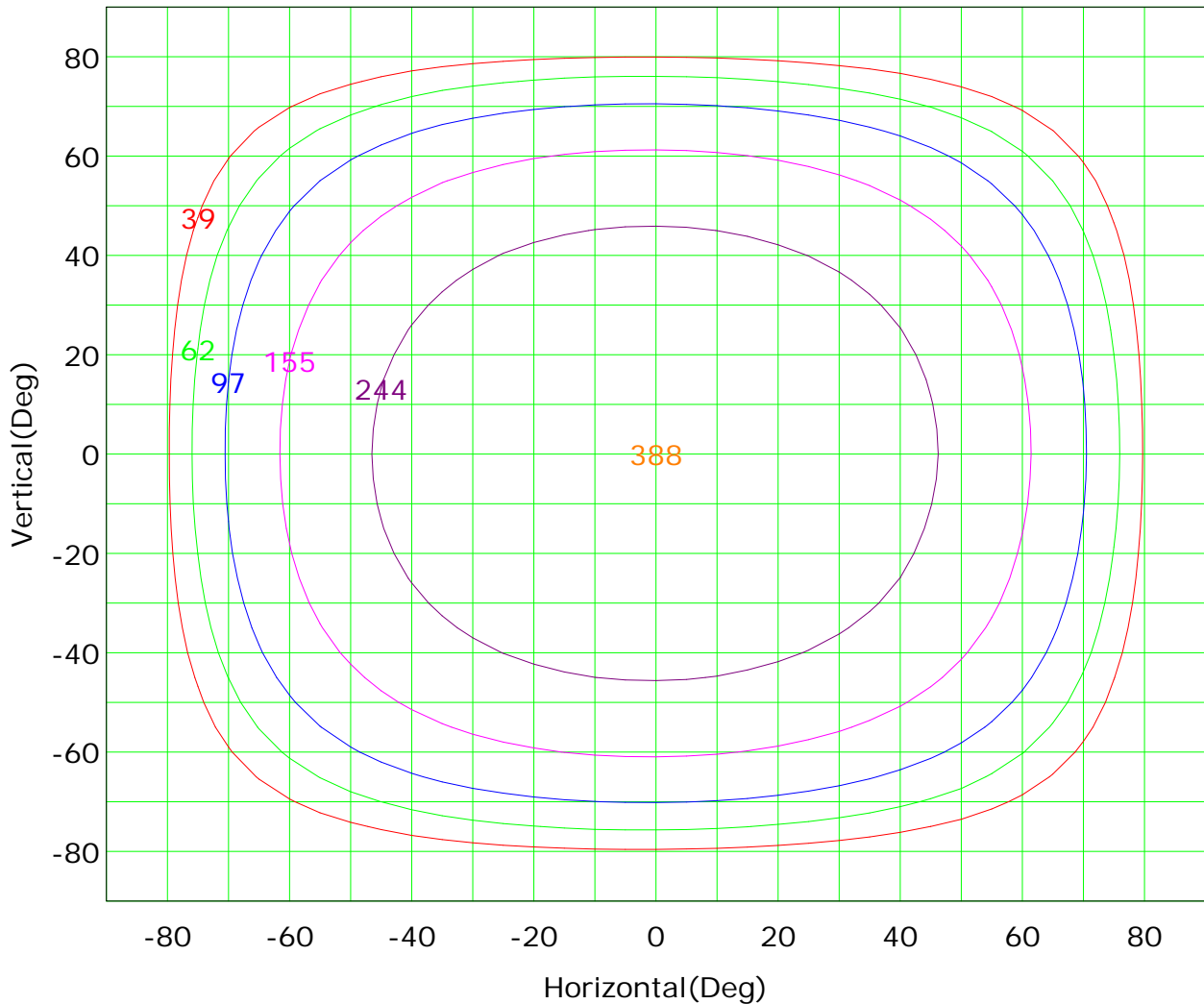

Imax (100%): 388 cd

— ( 10%):	39 cd	— ( 16%):	62 cd
— ( 25%):	97 cd	— ( 40%):	155 cd
— ( 63%):	244 cd	— (100%):	388 cd

C Plane (°):0.0-360.0: 10.0

Test Lab:

Test Type: TYPE C

Temperature:

Operator:

Gamma Plane (°):0.0-180.0:1.0

Test Device: GPM-2000

Distance: 7.970 m

Humidity:

Inspector:



## Isocandela (sphere)

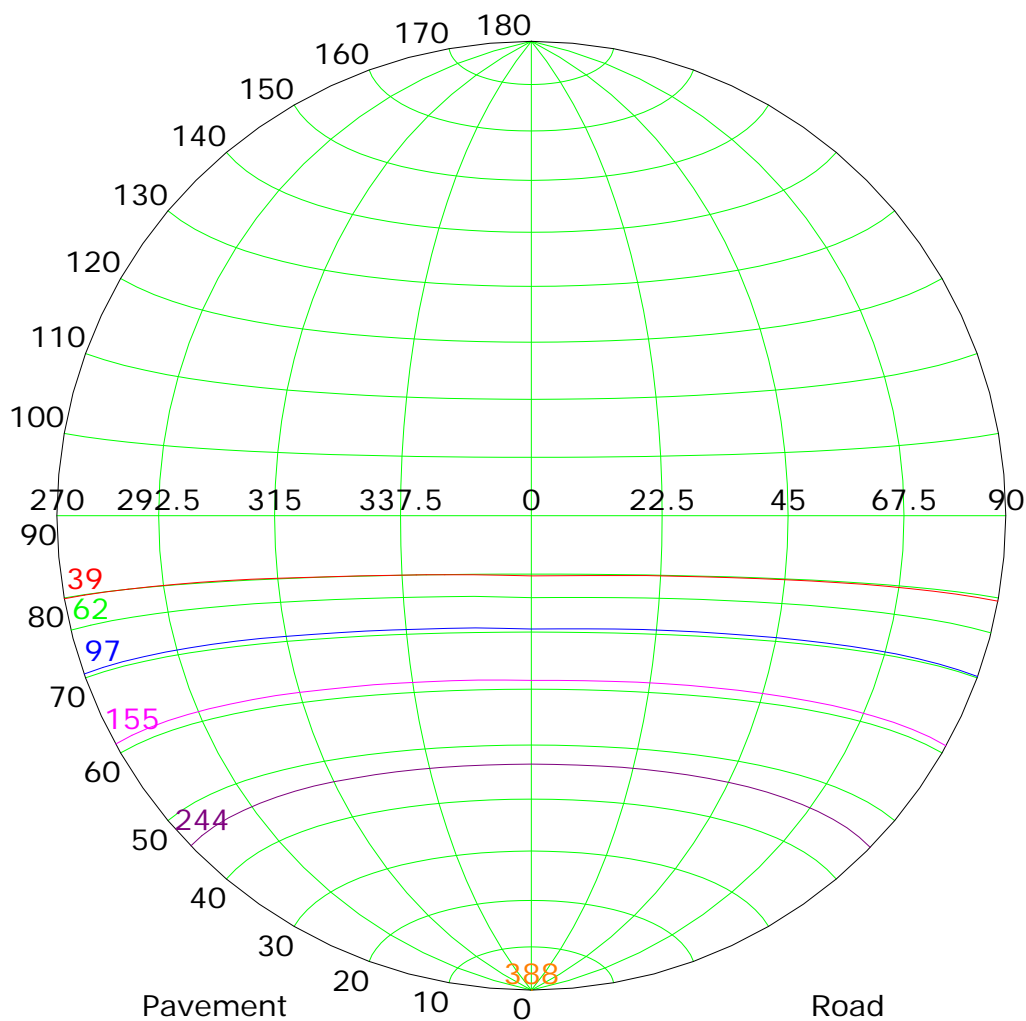

Imax (100%): 388 cd

— ( 10%):	39 cd	— ( 16%):	62 cd
— ( 25%):	97 cd	— ( 40%):	155 cd
— ( 63%):	244 cd	— (100%):	388 cd

C Plane (°):0.0-360.0: 10.0  
 Test Lab:  
 Test Type: TYPE C  
 Temperature:  
 Operator:

Gamma Plane (°):0.0-180.0:1.0  
 Test Device: GPM-2000  
 Distance: 7.970 m  
 Humidity:  
 Inspector:



## IsoLux Plot

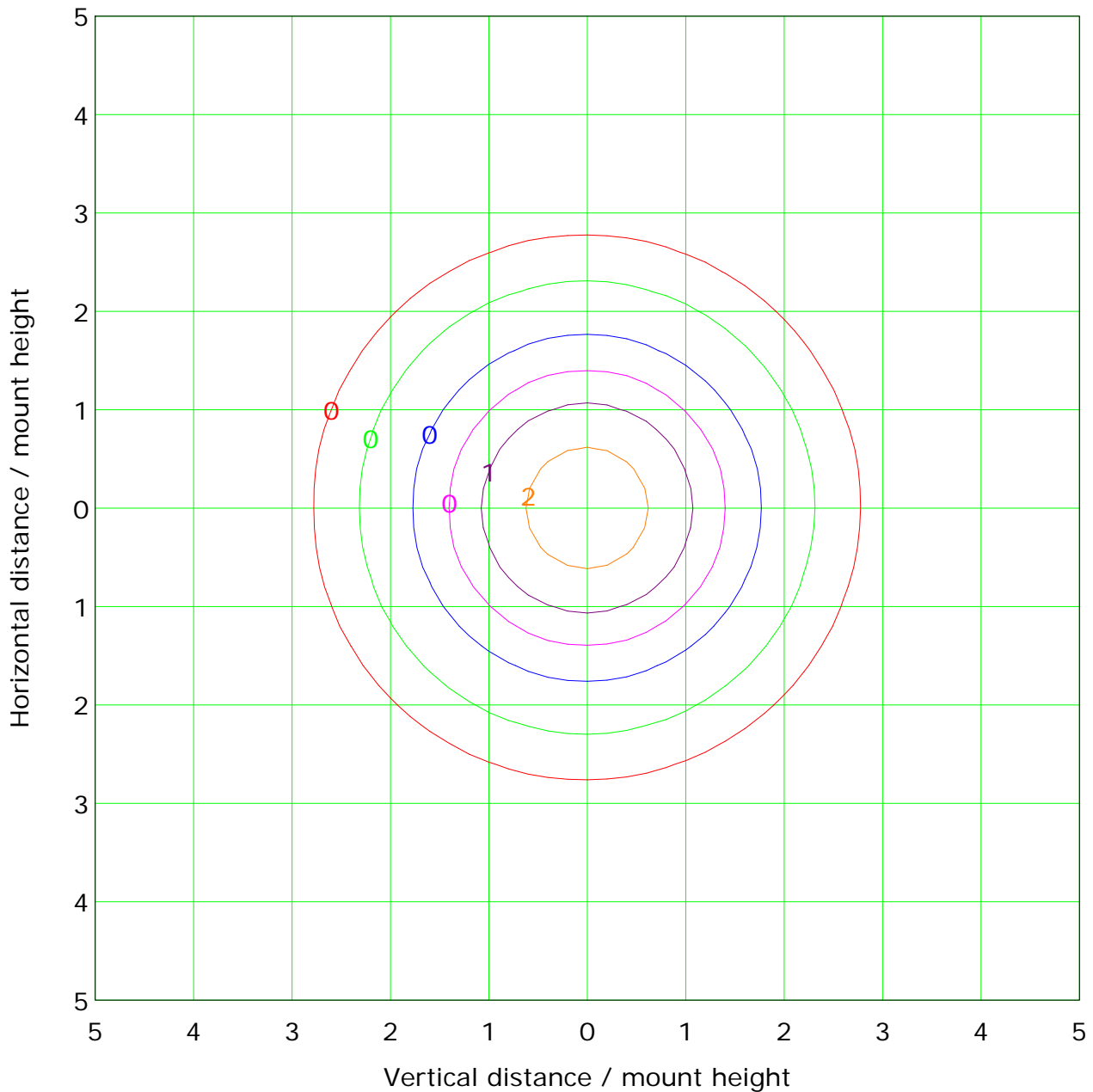

Mounting Height: 10.0m		Max Lux(100%): 3.9 lx	
— ( 1%):	0.0 lx	— ( 2%):	0.1 lx
— ( 5%):	0.2 lx	— (10%):	0.4 lx
— (20%):	0.8 lx	— (50%):	1.9 lx
— (100%):	3.9 lx		

C Plane (°):0.0-360.0: 10.0  
 Test Lab:  
 Test Type: TYPE C  
 Temperature:  
 Operator:

Gamma Plane (°):0.0-180.0:1.0  
 Test Device: GPM-2000  
 Distance: 7.970 m  
 Humidity:  
 Inspector:



## Lum Limit Curve

Dazzle	Quality	Illuminance (lx)							
		a	b	c	d	e	f	g	h
1.15	A	2000	1000	500	<=300				
1.50	B		2000	1000	500	<=300			
1.85	C			2000	1000	500	<=300		
2.20	D				2000	1000	500	<=300	
2.55	E					2000	1000	500	<=300

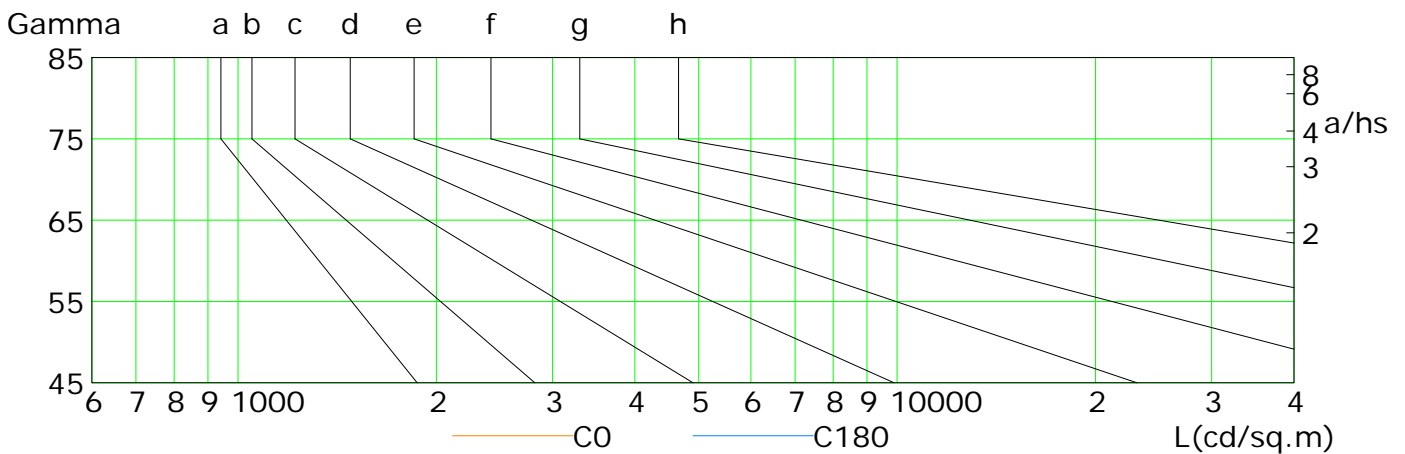
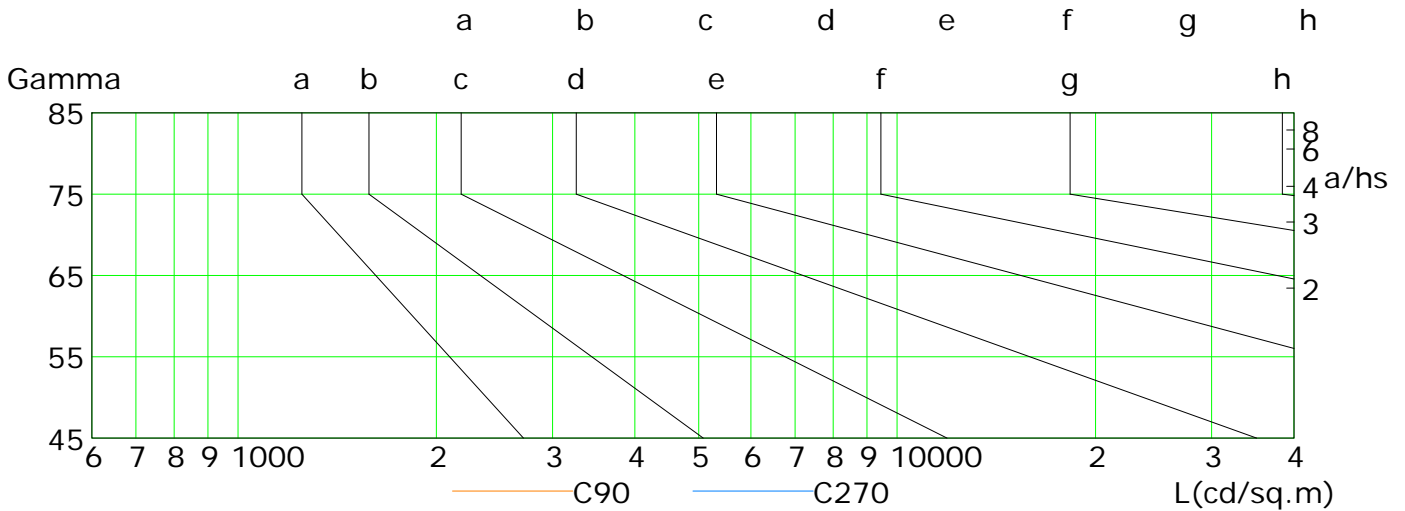

L(cd/sq.m)	G45	G50	G55	G60	G65	G70	G75	G80	G85
C0	253	225	196	165	133	101	68	37	11
C90	248	220	191	161	130	98	66	36	12
C180	251	224	195	164	133	100	68	37	12
C270	249	222	193	163	132	100	68	38	13

C Plane (°):0.0-360.0: 10.0

Test Lab:

Test Type: TYPE C

Temperature:

Operator:

Gamma Plane (°):0.0-180.0:1.0

Test Device: GPM-2000

Distance: 7.970 m

Humidity:

Inspector:





## Illuminance at a Distance

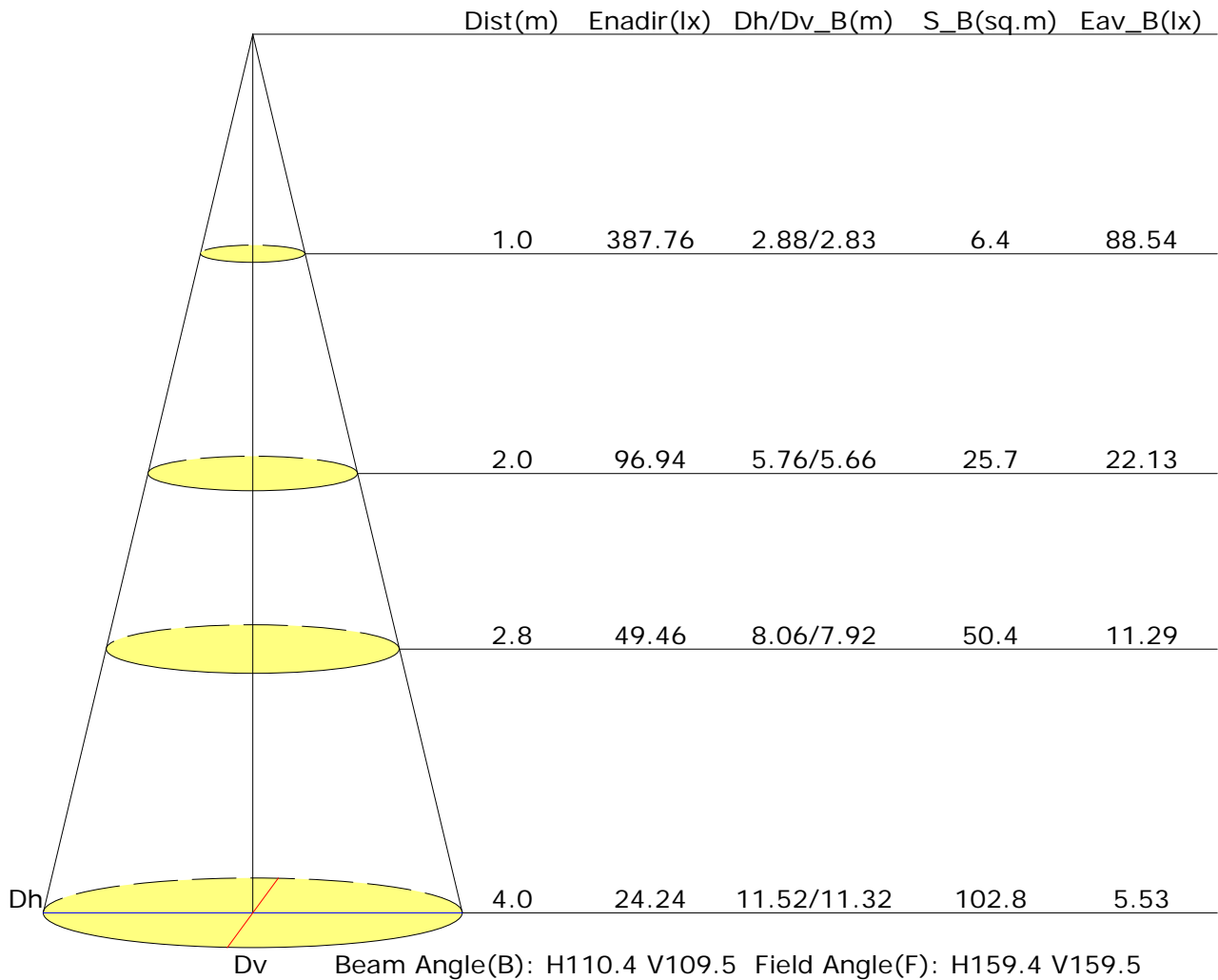



## Vertical IsoLux Plot

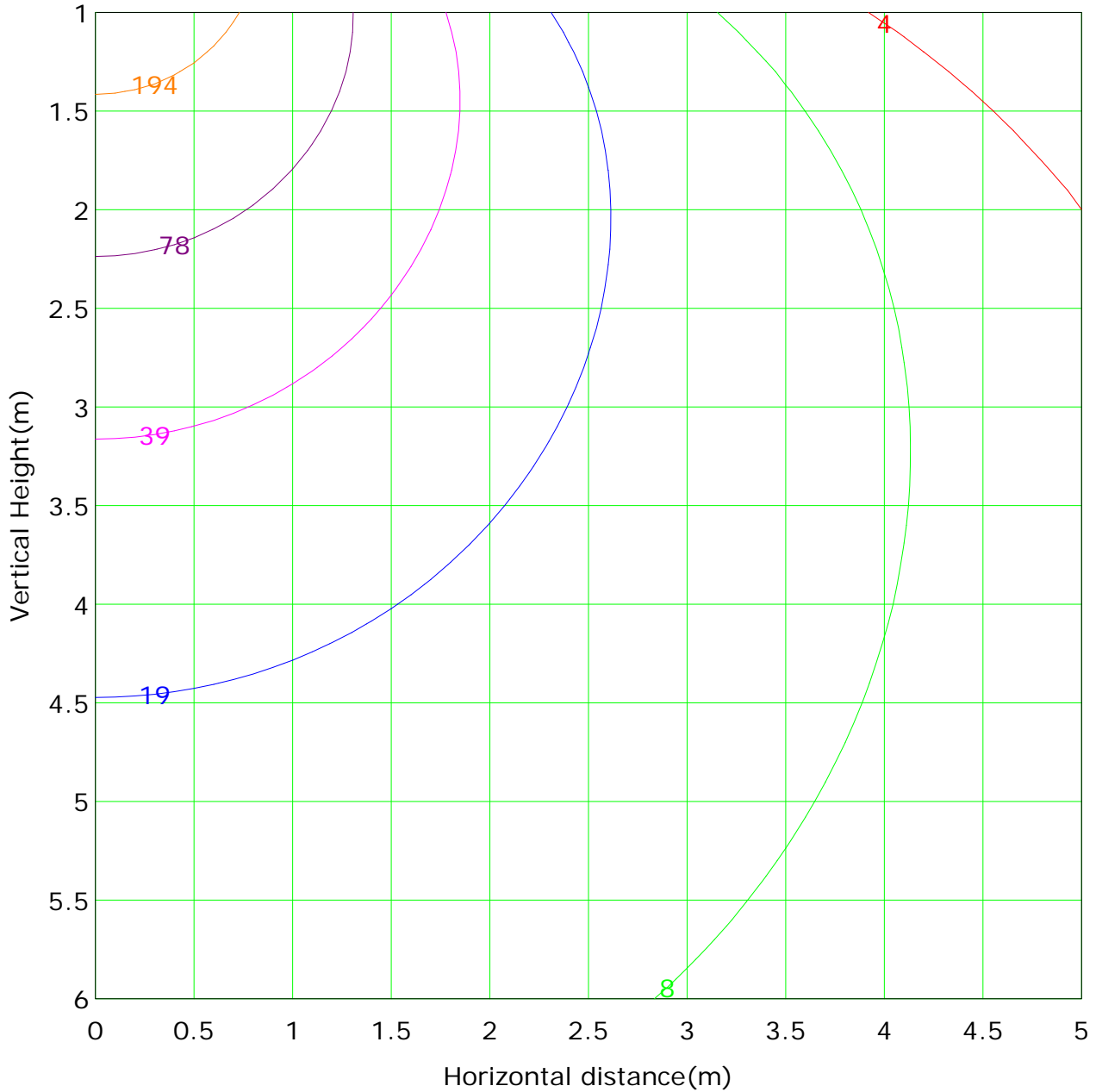

Lowest(m): 1.0m	Highest(m): 6.0m	Max Lux: 387.8 lx
— ( 1%): 3.9 lx	— ( 2%): 7.8 lx	— ( 10%): 38.8 lx
— ( 5%): 19.4 lx	— ( 20%): 77.6 lx	— ( 50%): 193.9 lx
— (100%): 387.8 lx		

C Plane (°):0.0-360.0: 10.0  
 Test Lab:  
 Test Type: TYPE C  
 Temperature:  
 Operator:

Gamma Plane (°):0.0-180.0:1.0  
 Test Device: GPM-2000  
 Distance: 7.970 m  
 Humidity:  
 Inspector:



Report No.:

Test Time: 04/09/2018 12:07

## Luminaire Property

Luminaire Manufacturer: Lighting Line  
 Luminaire Description: LLP-SL06-05 + LLD-05-FS  
 Lamp Description: Strip 14,4W/m 60led/m      Number of Lamps: 1  
 Lumens per Lamp: 1579 lm      Voltage: 24.0 V  
 Current: 0.593 A      Power: 14.23 W  
 Power Factor: 1.000

## Photometric Results

CIE Class: Direct	Total Rated Lamp Lumens: 1579.0 lm
Measurement Flux: 1060 lm	Efficiency: 67.13%
Downward Ratio: 66.78%	Upward Ratio: 0.35%
Field Angle(C0/C180,C90/C270,C45/C225,C135/315): 162.3, 163.5, 163.0, 163.1	
Beam Angle(C0/C180,C90/C270,C45/C225,C135/315): 106.5, 106.0, 106.4, 106.4	
Luminaire Efficacy Rating (LER): 74.54	Central Intensity: 389.18 cd
Max. Intensity: 389.33 cd	Pos of Max. Intensity: H40 V1
S/MH(C0/C180): 1.21	S/MH(C90/C270): 1.20

Picture Of Luminaire

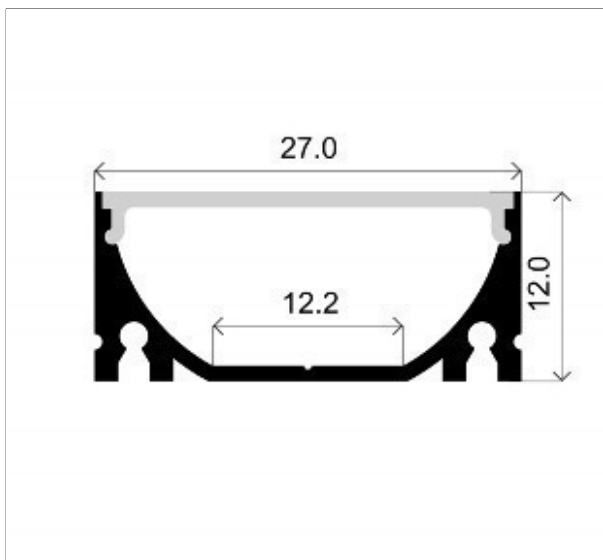

Luminous Intensity Distribution Curve

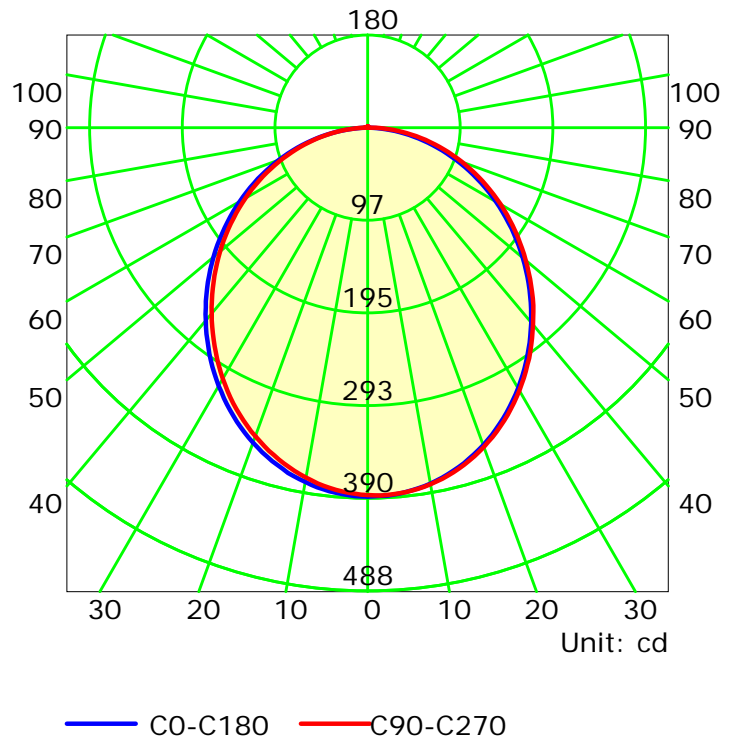

C Plane (°):0.0-360.0: 10.0  
 Test Lab:  
 Test Type: TYPE C  
 Temperature:  
 Operator:

Gamma Plane (°):0.0-180.0:1.0  
 Test Device: GPM-2000  
 Distance: 7.970 m  
 Humidity:  
 Inspector:



## Luminous Intensity Distribution Curve

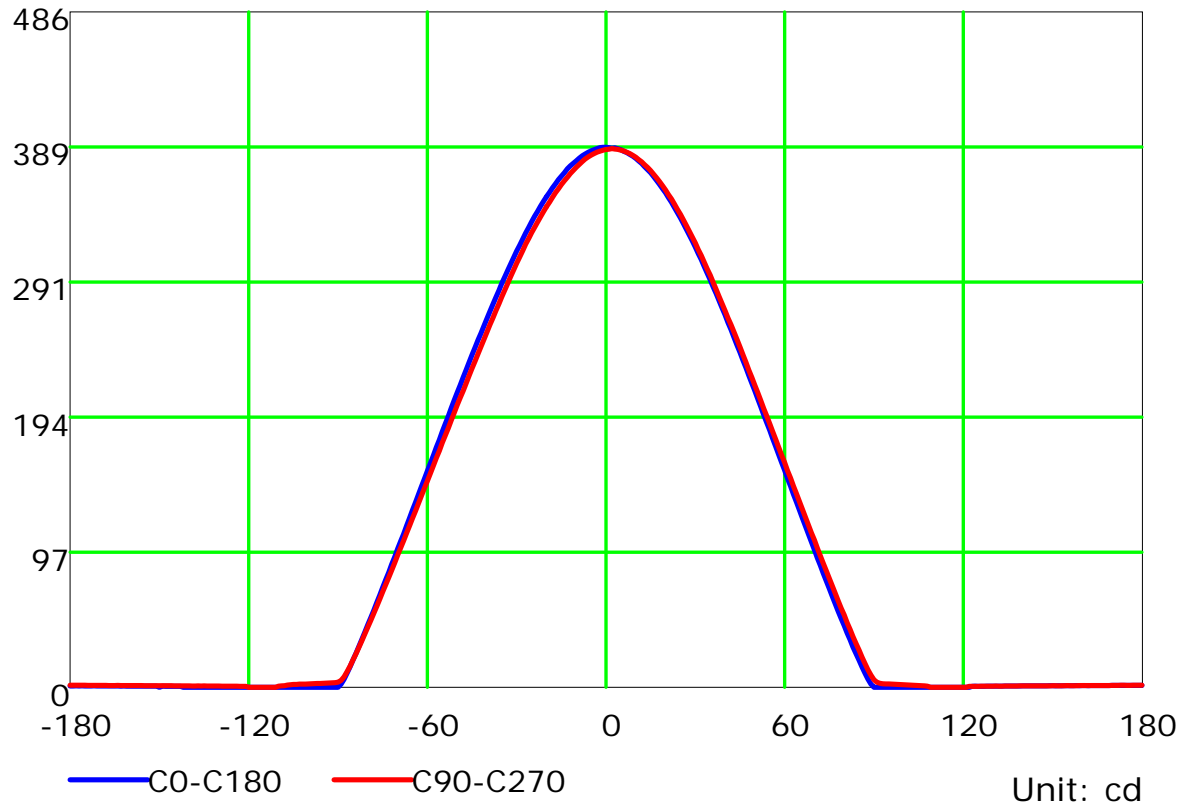
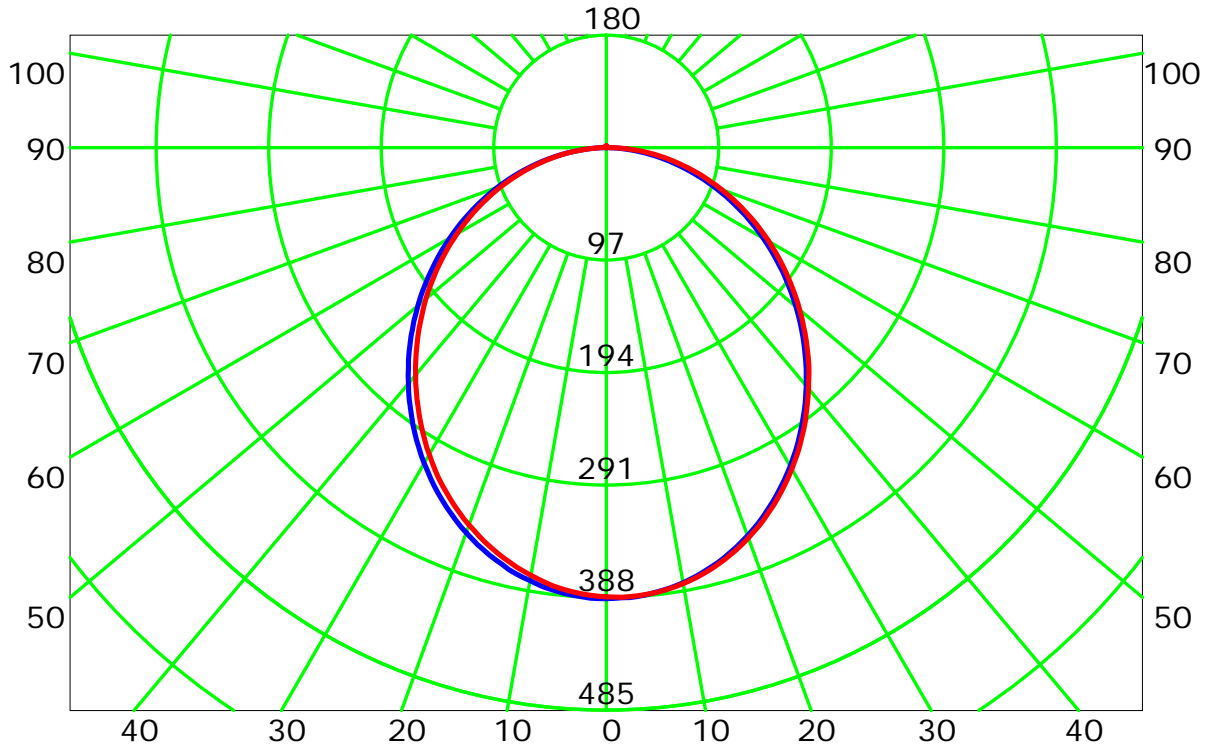

C Plane (°):0.0-360.0: 10.0  
Test Lab:  
Test Type: TYPE C  
Temperature:  
Operator:

Gamma Plane (°):0.0-180.0:1.0  
Test Device: GPM-2000  
Distance: 7.970 m  
Humidity:  
Inspector:



## Luminous Intensity Distribution Curve(cd/klm)

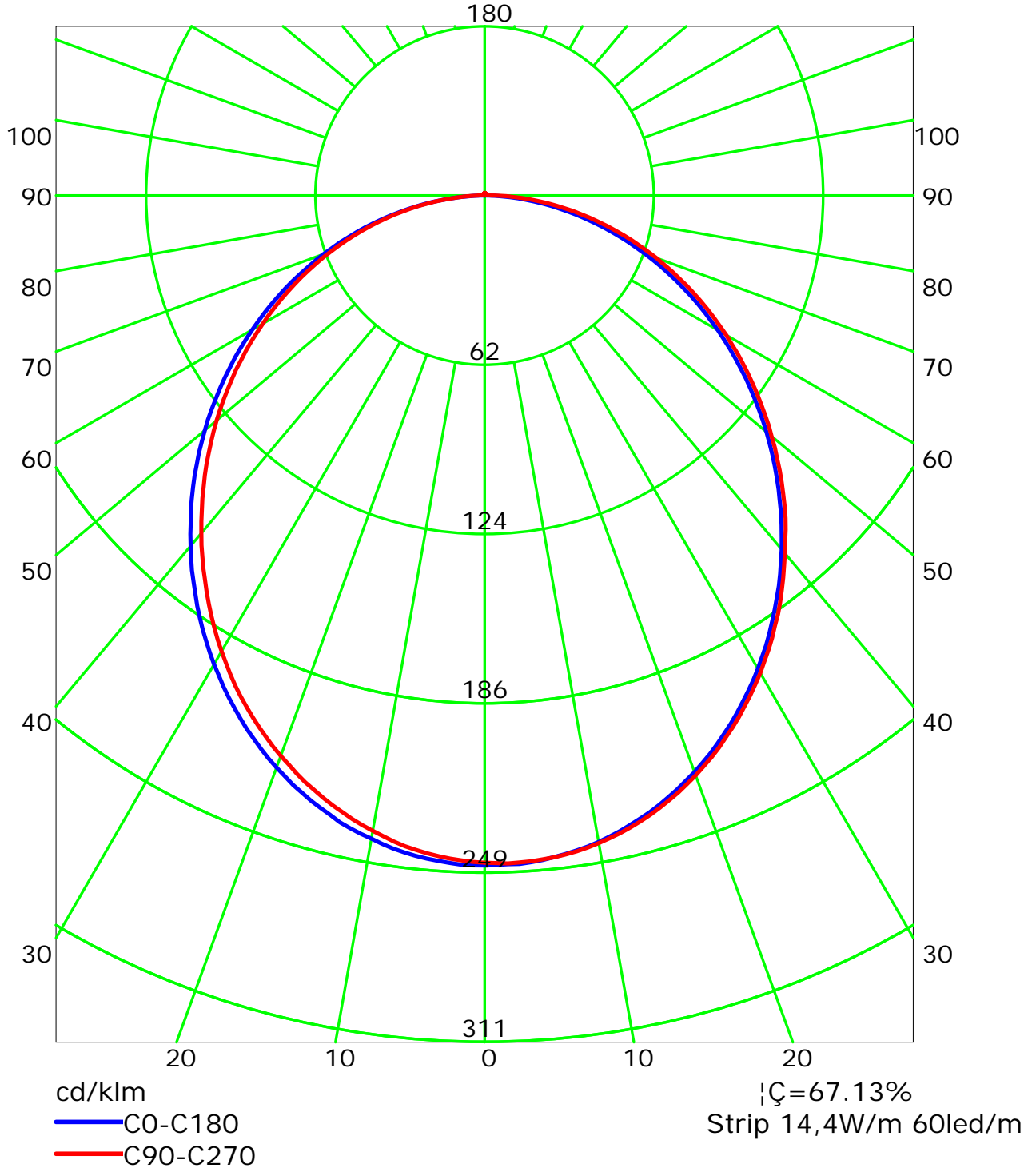

C Plane (°):0.0-360.0: 10.0  
 Test Lab:  
 Test Type: TYPE C  
 Temperature:  
 Operator:

Gamma Plane (°):0.0-180.0:1.0  
 Test Device: GPM-2000  
 Distance: 7.970 m  
 Humidity:  
 Inspector:



## Isocandela (rectangle)

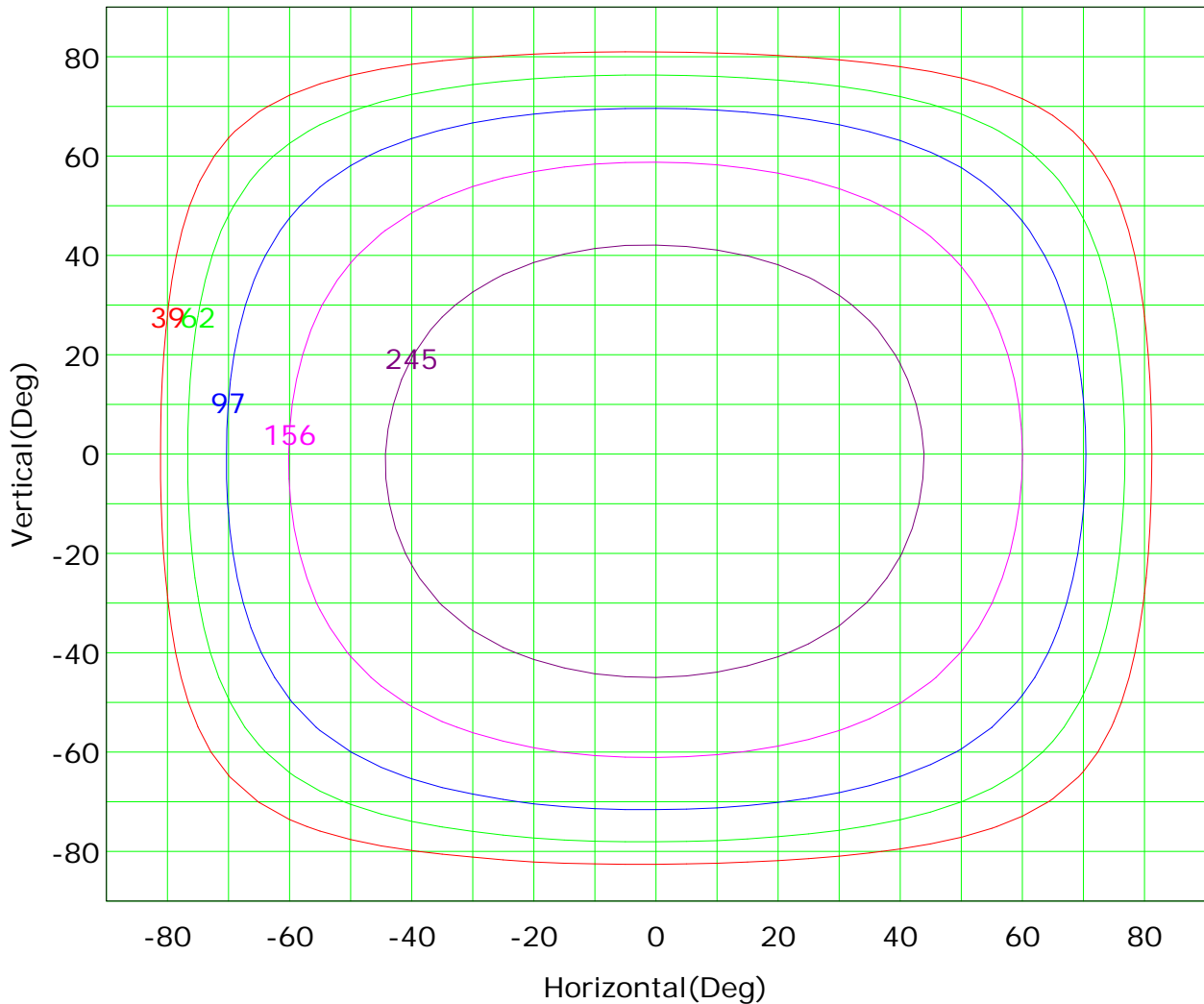

Imax (100%): 389 cd

— ( 10%):	39 cd	— ( 16%):	62 cd
— ( 25%):	97 cd	— ( 40%):	156 cd
— ( 63%):	245 cd	— (100%):	389 cd

C Plane (°):0.0-360.0: 10.0

Test Lab:

Test Type: TYPE C

Temperature:

Operator:

Gamma Plane (°):0.0-180.0:1.0

Test Device: GPM-2000

Distance: 7.970 m

Humidity:

Inspector:



## Isocandela (sphere)

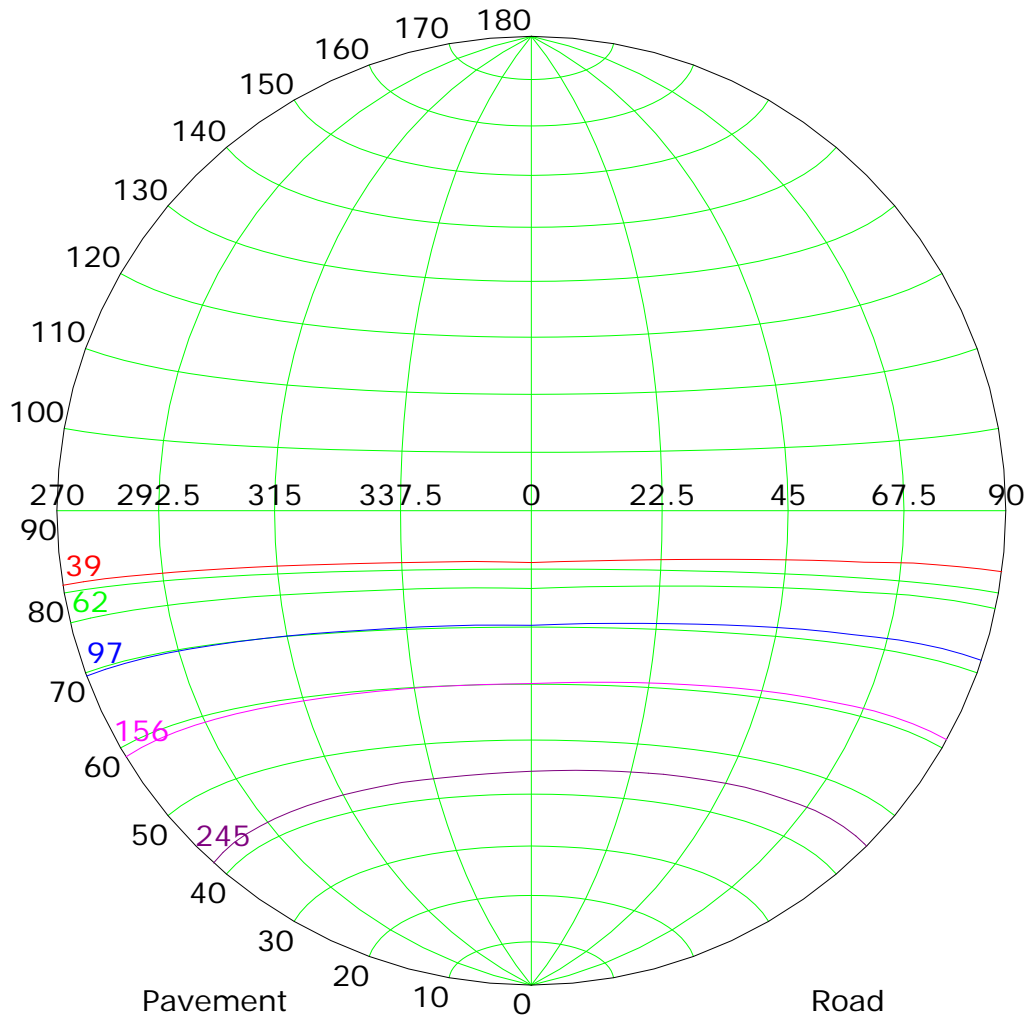

Imax (100%): 389 cd

— ( 10%):	39 cd	— ( 16%):	62 cd
— ( 25%):	97 cd	— ( 40%):	156 cd
— ( 63%):	245 cd	— (100%):	389 cd

C Plane (°):0.0-360.0: 10.0  
 Test Lab:  
 Test Type: TYPE C  
 Temperature:  
 Operator:

Gamma Plane (°):0.0-180.0:1.0  
 Test Device: GPM-2000  
 Distance: 7.970 m  
 Humidity:  
 Inspector:



## IsoLux Plot

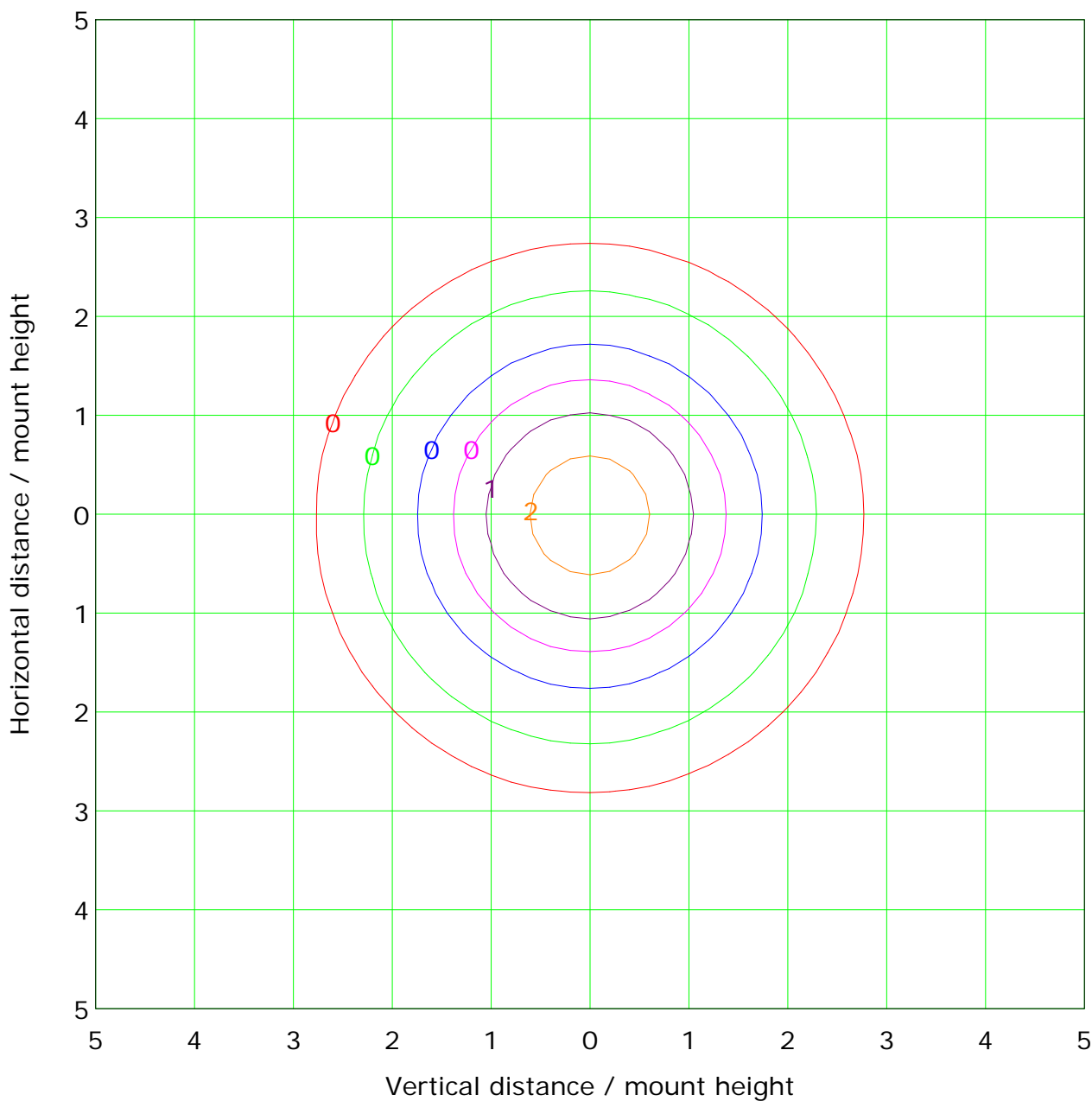

Mounting Height: 10.0m		Max Lux(100%): 3.9 lx	
— ( 1%):	0.0 lx	— ( 2%):	0.1 lx
— ( 5%):	0.2 lx	— (10%):	0.4 lx
— (20%):	0.8 lx	— (50%):	1.9 lx
— (100%):	3.9 lx		

C Plane (°):0.0-360.0: 10.0  
 Test Lab:  
 Test Type: TYPE C  
 Temperature:  
 Operator:

Gamma Plane (°):0.0-180.0:1.0  
 Test Device: GPM-2000  
 Distance: 7.970 m  
 Humidity:  
 Inspector:





## Lum Limit Curve

Dazzle	Quality	Illuminance (lx)							
		a	b	c	d	e	f	g	h
1.15	A	2000	1000	500	<=300				
1.50	B		2000	1000	500	<=300			
1.85	C			2000	1000	500	<=300		
2.20	D				2000	1000	500	<=300	
2.55	E					2000	1000	500	<=300

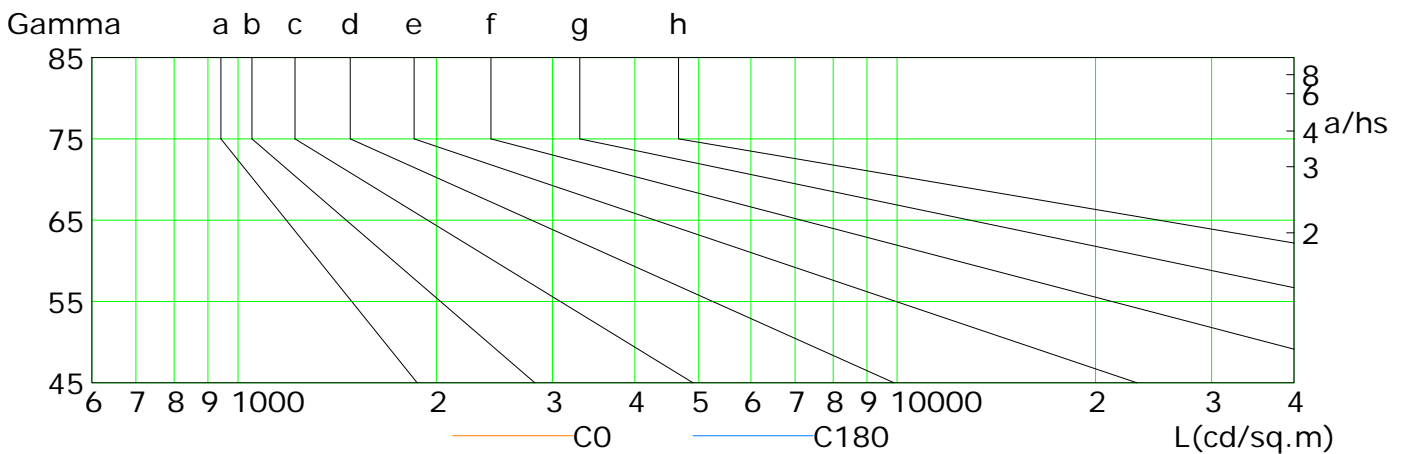
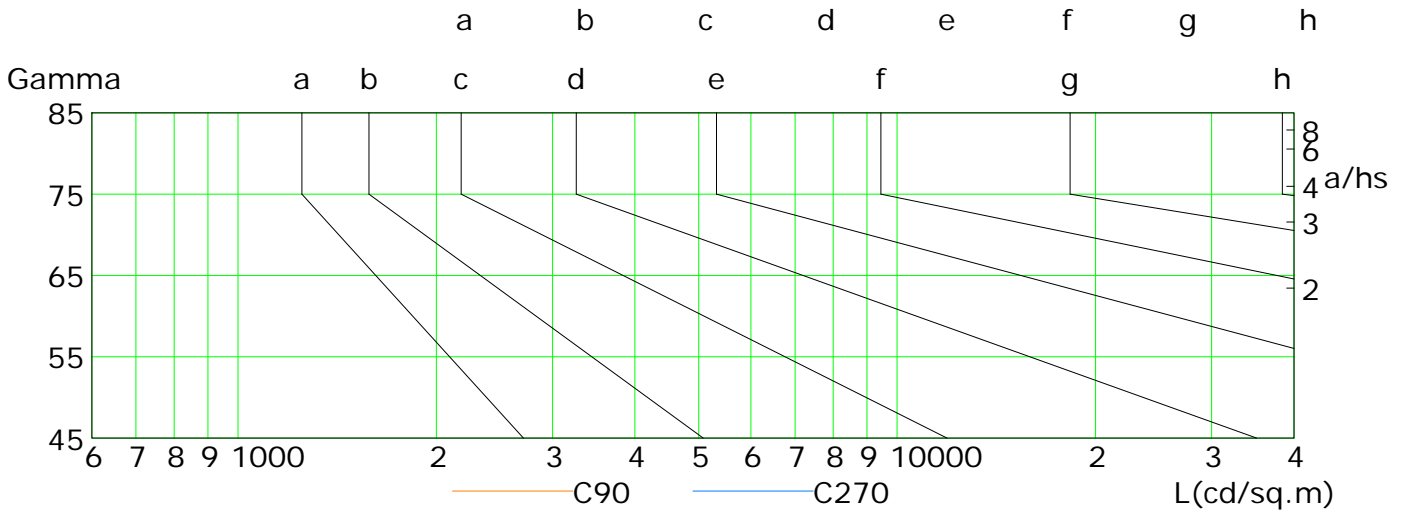

L(cd/sq.m)	G45	G50	G55	G60	G65	G70	G75	G80	G85
C0	241	214	185	156	128	99	71	45	20
C90	245	218	190	162	134	106	79	52	27
C180	240	212	184	156	128	100	72	45	20
C270	230	203	176	149	122	95	69	43	20

C Plane (°):0.0-360.0: 10.0  
 Test Lab:  
 Test Type: TYPE C  
 Temperature:  
 Operator:

Gamma Plane (°):0.0-180.0:1.0  
 Test Device: GPM-2000  
 Distance: 7.970 m  
 Humidity:  
 Inspector:



## Illuminance at a Distance

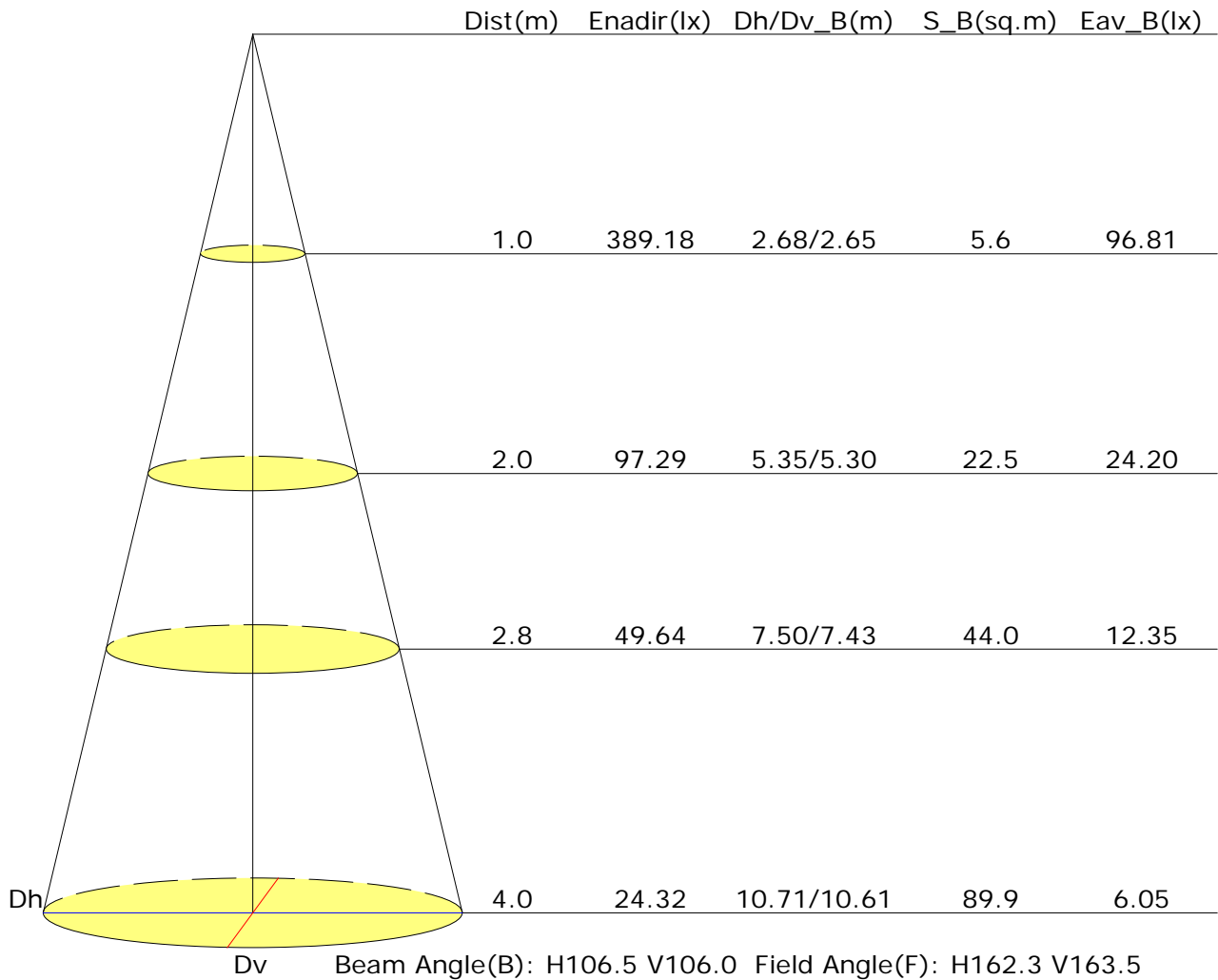



## Vertical IsoLux Plot

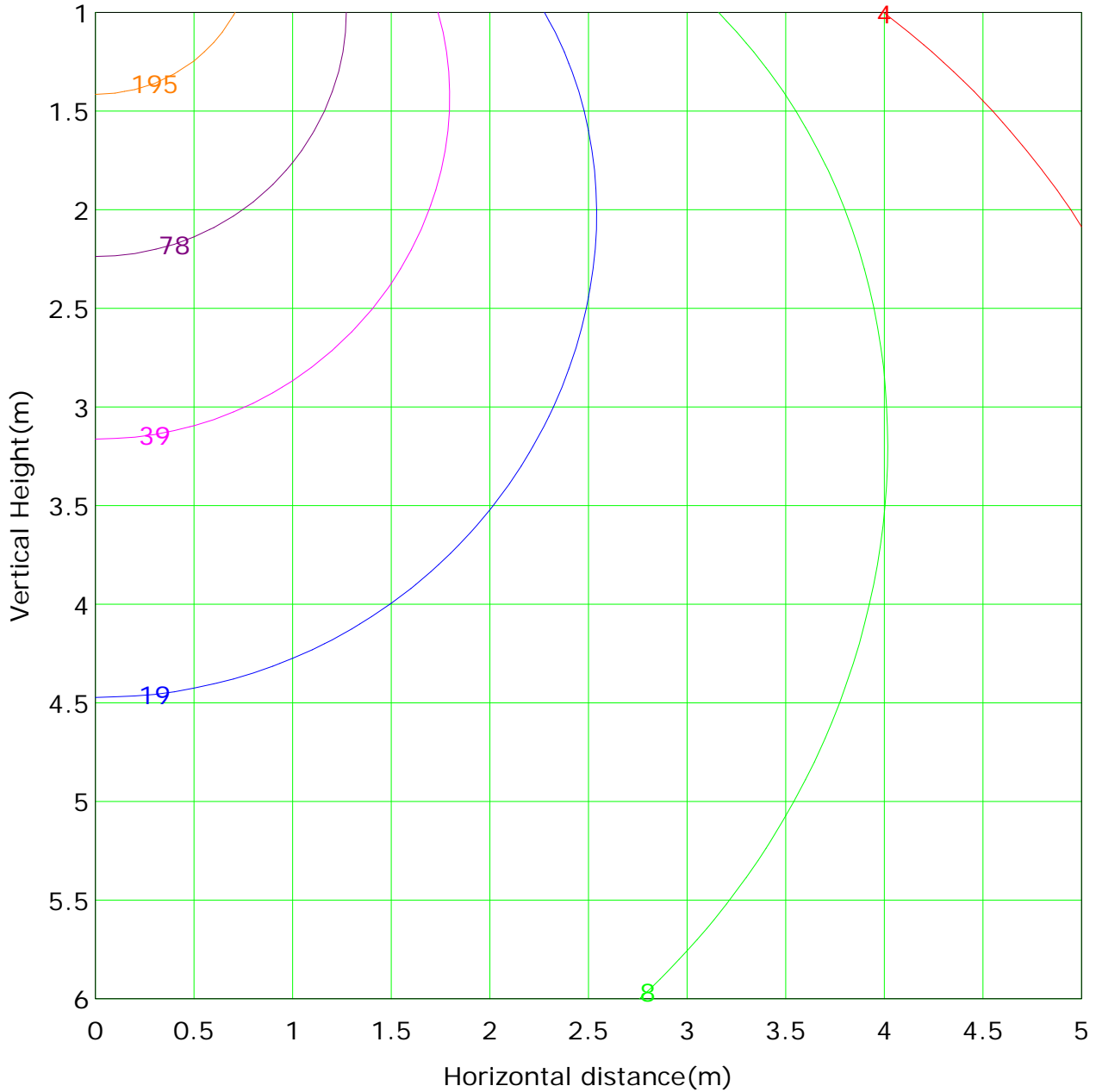

Lowest(m): 1.0m	Highest(m): 6.0m	Max Lux: 389.2 lx
— ( 1%): 3.9 lx	— ( 2%): 7.8 lx	
— ( 5%): 19.5 lx	— (10%): 38.9 lx	
— (20%): 77.8 lx	— (50%): 194.6 lx	
— (100%): 389.2 lx		

C Plane (°):0.0-360.0: 10.0  
 Test Lab:  
 Test Type: TYPE C  
 Temperature:  
 Operator:

Gamma Plane (°):0.0-180.0:1.0  
 Test Device: GPM-2000  
 Distance: 7.970 m  
 Humidity:  
 Inspector: